

# CATALOGUE II.2011



# EQUIPMENT **VIGOR**<sup>®</sup>

[www.vigor-equipment.com](http://www.vigor-equipment.com)

Valid until December 31, 2011 / Valable jusqu'au 31.12.2011

V2382



**Tool Trolley VIGOR 1000 incl. assortment**  
**Servante d'atelier VIGOR 1000 incl. assortiment**

VIGOR 1000  
 Tool Trolley  
 with assortment  
 V1894,  
 EAN 4047728018944

VIGOR 1000  
 Servante d'atelier  
 avec assortiment  
 V1894,  
 EAN 4047728018944



VIGOR 1000  
 Tool Trolley  
 with tool chest  
 and assortment  
 V1895,  
 EAN 4047728018951

VIGOR 1000  
 Servante d'atelier  
 avec coffre à tiroirs  
 et assortiment  
 V1895,  
 EAN 4047728018951



V1408



**Work Bench VIGOR 800 incl. assortment**  
**Établi mobile VIGOR 800 incl. assortiment**

# VIGOR 800

Work Bench with 8 drawers and tool assortment in 2-component soft foam inserts V1749, EAN 4047728017497

Établi mobile avec 8 tiroirs et assortiment d'outils en garnitures en mousse souple bimatière V1749, EAN 4047728017497

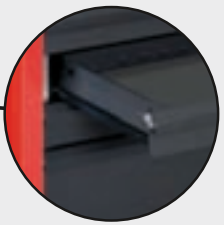
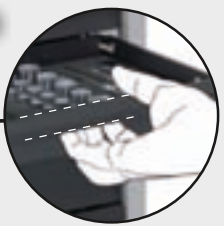
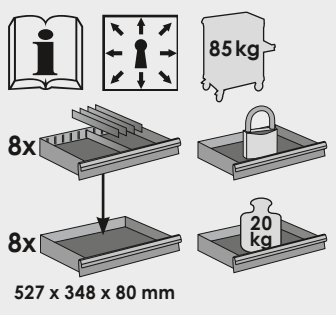

100 % sliding-out  
Ouverture à 100 %

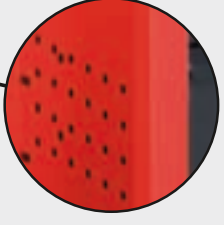

H 934 x W 1040 x D 520 mm  
H 934 x L 1040 x P 520 mm



**Work Bench**  
**Établi mobile**  
**Made in Germany!**

V1516

V1747

V1518

V1519

Drawer 1 / Tiroir 1



Drawer 2 / Tiroir 2



Drawer 3 / Tiroir 3



V1520

V1521

V1522

V1525

Drawer 4 / Tiroir 4



Drawer 5 / Tiroir 5



Drawer 6 / Tiroir 6



V1485

V1523

V1746

V1748

Drawer 7 / Tiroir 7

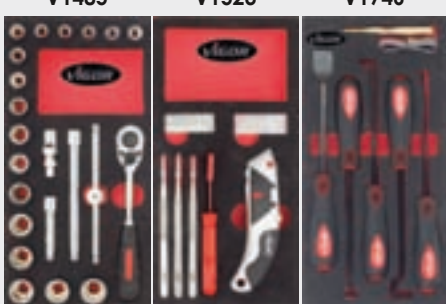

Drawer 8 / Tiroir 8

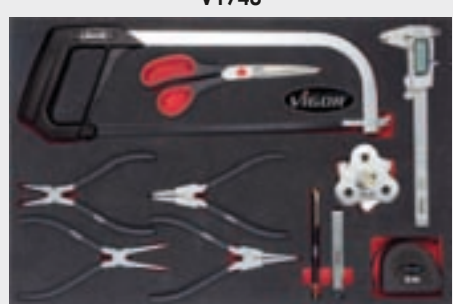

**Tool Trolley VIGOR 700 incl. assortment**  
**Servante d'atelier VIGOR 700 incl. assortment**



# VIGOR 700

Tool Trolley with 7 drawers and tool assortment  
 in 2-component soft foam inserts  
 V1487, EAN 4047728014878

Servante d'atelier avec 7 tiroirs et assortiment  
 d'outils en garnitures en mousse souple bimatière  
 V1487, EAN 4047728014878

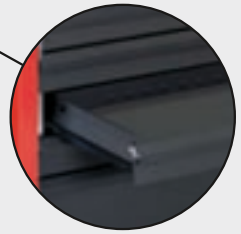
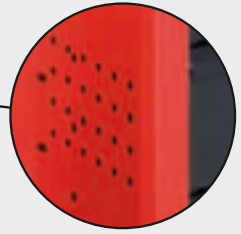
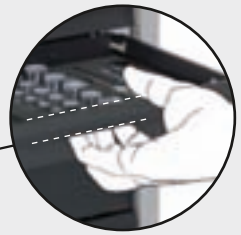
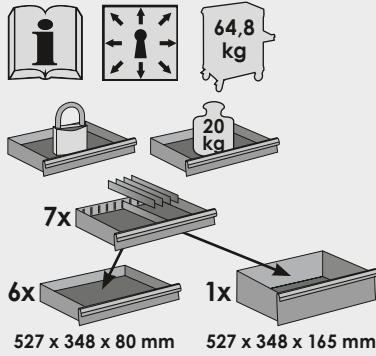

H 913 x W 778 x D 496 mm  
 H 913 x L 778 x P 496 mm

100 % sliding-out  
 Ouverture à 100 %

**Tool Trolley**  
**Servante d'atelier**  
**Made in Germany!**

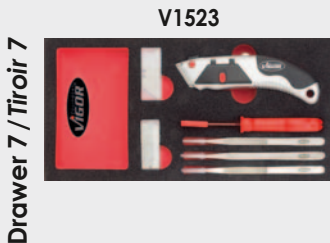
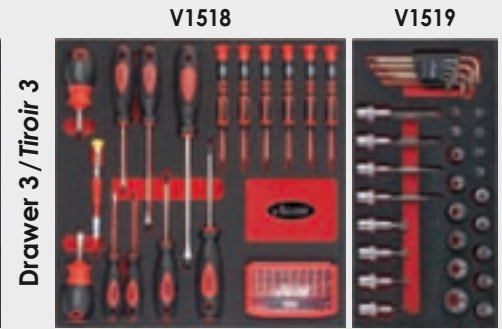
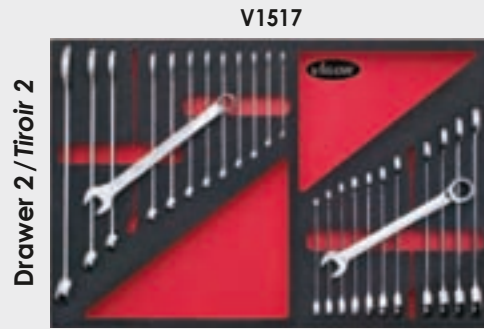

# VIGOR 700

VIGOR 700 with 7 drawers and tool assortment in 2-component soft foam inserts V1483, EAN 4047728014830

VIGOR 700 avec 7 tiroirs et assortiment d'outils en garnitures en mousse souple bimatière V1483, EAN 4047728014830

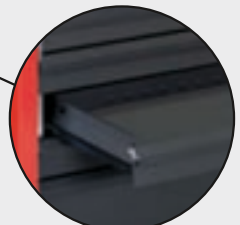
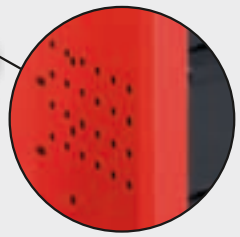
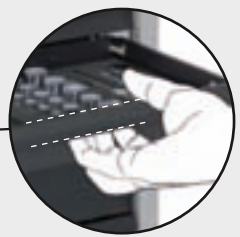
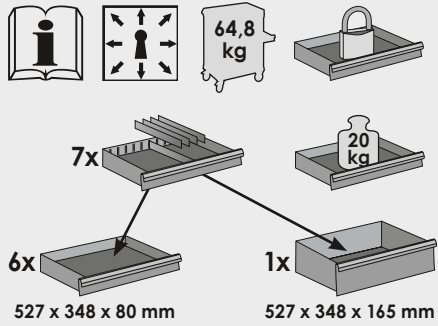

H 913 x W 778 x D 496 mm  
 H 913 x L 778 x P 496 mm

100 % sliding-out  
 Ouverture à 100 %

**Tool Trolley**  
**Servante d'atelier**  
**Made in Germany!**



► Additional colour:  
 ► Autre couleur :

	VIGOR No.	RAL	EAN 4047728+
RAL 7004	V1582	7004	015820

V1516

V1517

V1518

V1519

Drawer 1 / Tiroir 1



Drawer 2 / Tiroir 2



Drawer 3 / Tiroir 3



V1520

V1521

V1522

Drawer 4 / Tiroir 4



Drawer 5 / Tiroir 5



**Tool Trolley VIGOR 600 incl. assortment**  
**Servante d'atelier VIGOR 600 incl. assortiment**



# VIGOR 600

VIGOR 600 with 6 drawers and tool assortment in 2-component soft foam inserts V1620, EAN 4047728016209

VIGOR 600 avec 6 tiroirs et assortiment d'outils en garnitures en mousse souple bimatière V1620, EAN 4047728016209

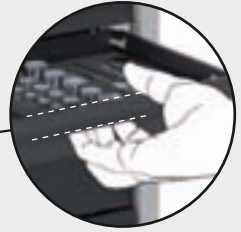
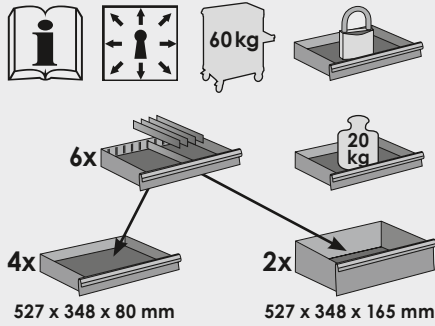

100 % sliding-out  
Ouverture à 100 %

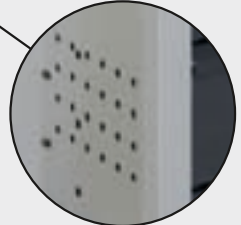

H 913 x W 778 x D 496 mm  
H 913 x L 778 x P 496 mm



**Tool Trolley**  
**Servante d'atelier**  
**Made in Germany!**

V1661

V1521

V1665

V1658

Drawer 1 / Tiroir 1

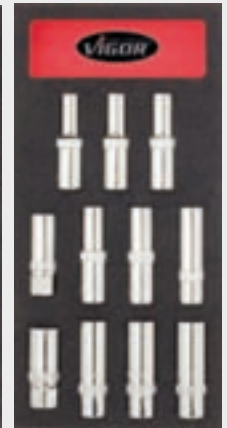

Drawer 2 / Tiroir 2

V1517

V1664

V1660

V1682

Drawer 3 / Tiroir 3

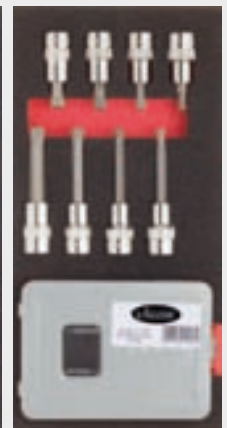
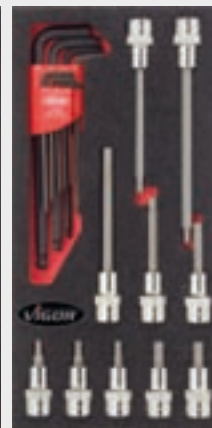
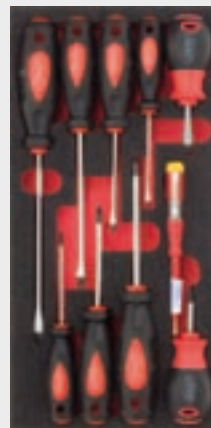

Drawer 4 / Tiroir 4

## VIGOR 500

VIGOR 500 with 5 drawers and tool assortment in 2-component soft foam inserts

V1619, EAN 4047728016193

VIGOR 500 avec 5 tiroirs et assortiment d'outils en garnitures en mousse souple bimatière

V1619, EAN 4047728016193

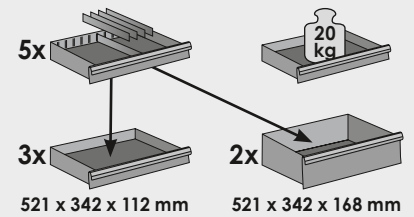

H 930 x W 700 x D 400 mm  
H 930 x L 700 x P 400 mm



**Tool Trolley**  
**Servante d'atelier**  
**Made in Germany!**



V1665



V1658

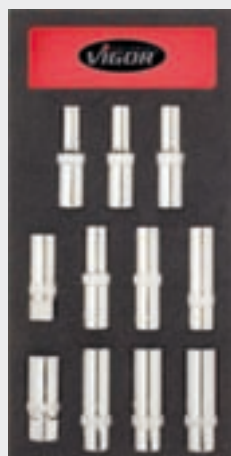

V1664

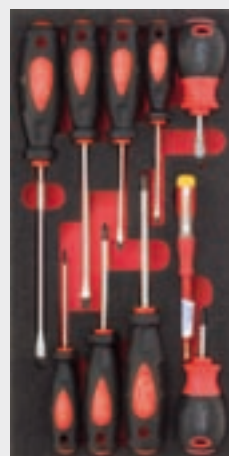

V1521





# Tool Trolley VIGOR 500

## Servante d'atelier VIGOR 500

EQUIPMENT  
**VIGOR**

## VIGOR 500

VIGOR 500 with 5 drawers  
V1252, EAN 4047728012522

VIGOR 500 avec 5 tiroirs  
V1252, EAN 4047728012522

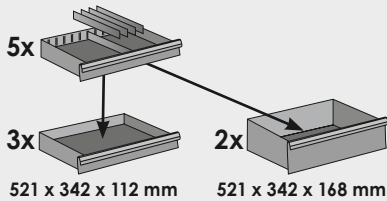

► Available colours:  
► Les couleurs au choix sont :

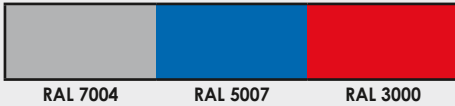

VIGOR No.	RAL	EAN 4047728+
V1252	7004	012522
V1396	5007	013963
V1382	3000	013826

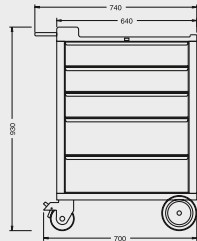

**Tool Trolley**  
**Servante d'atelier**  
**Made in Germany!**

VIGOR 500 with 6 drawers  
V1399, EAN 4047728013994

VIGOR 500 avec 6 tiroirs  
V1399, EAN 4047728013994

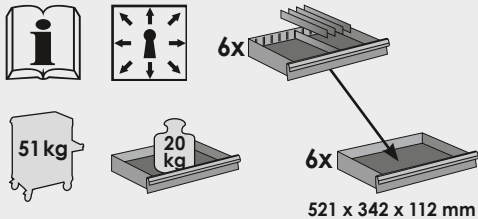

► Available colours:  
► Les couleurs au choix sont :



VIGOR No.	RAL	EAN 4047728+
V1399	7004	013994
V1397	5007	013970
V1398	3000	013987



**Tool Trolley**  
**Servante d'atelier**  
**Made in Germany!**

# Tool Trolley VIGOR 600 / 700

## Servante d'atelier VIGOR 600 / 700



### VIGOR 600

VIGOR 600 with 6 drawers  
V1627, EAN4047728016278

VIGOR 600 avec 6 tiroirs  
V1627, EAN4047728016278

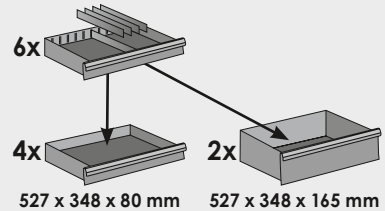

▶ Available colours:  
▶ Les couleurs au choix sont :



VIGOR No.	RAL	EAN 4047728+
V1251	7004	012515
V1628	5007	016285
V1627	3000	016278

**Tool Trolley**  
**Servante d'atelier**  
**Made in Germany!**



### VIGOR 700

VIGOR 700 with 7 drawers  
V1581, EAN4047728015813

VIGOR 700 avec 7 tiroirs  
V1581, EAN4047728015813

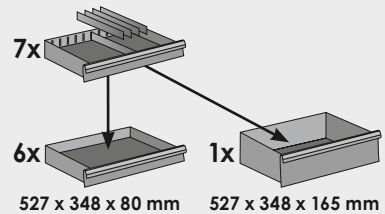

▶ Available colours:  
▶ Les couleurs au choix sont :

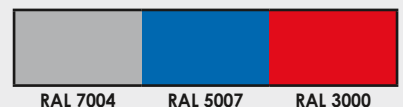

VIGOR No.	RAL	EAN 4047728+
V1581	7004	015813
V1578	5007	015783
V1527	3000	015271

**Tool Trolley**  
**Servante d'atelier**  
**Made in Germany!**

# VIGOR 800

VIGOR 800 with 8 drawers,  
incl. door  
V1705, EAN 4047728017053

VIGOR 800 avec 8 tiroirs,  
incl. porte  
V1705, EAN 4047728017053

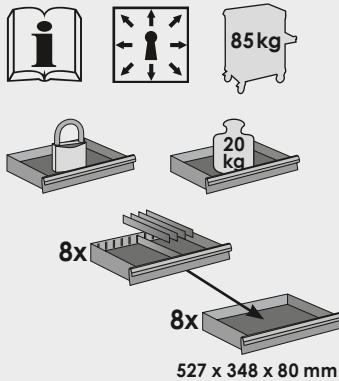

## Accessories for VIGOR 500, 600, 700 and 800 / Accessoires pour VIGOR 500, 600, 700 et 800

### For/Pour VIGOR 500

2 Tool bins, small  
• 2 pièces per package

2 Bacs à outils, petits  
• 2 pièces par paquet

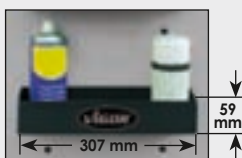

V1386,  
EAN 4047728013864

Price per 2 pieces / Prix par 2 pièces

Tool bin, big  
Bac à outils, grand



V1387,  
EAN 4047728013871

Price per piece / Prix par pièce

Torque Wrench Safe  
• lockable with padlock  
Coffre-fort  
pour une clé  
dynamométrique  
• avec cadenas,  
verrouillable



V1388,  
EAN 4047728013888

Price per piece / Prix par pièce

### For/Pour VIGOR 600, 700, 800

Can holder

• For 3 cans  
Support pour  
aérosol  
• Pour 3 aérosols

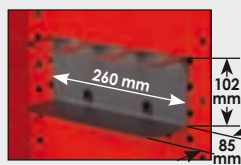

V1644,  
EAN 4047728016445

Price per piece / Prix par pièce

Document Holder  
Porte-document

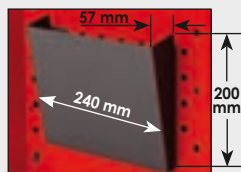

V1645,  
EAN 4047728016452

Price per piece / Prix par pièce

Tool bin, big  
Bac à outils, grand

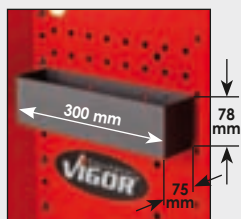

V1646,  
EAN 4047728016469

Price per piece / Prix par pièce

### For/Pour VIGOR 500, 600, 700, 800

Anti-Slipping Mat  
Tapis pour tiroir

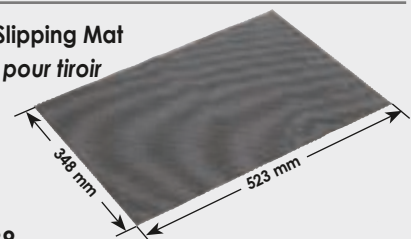

V1389,  
EAN 4047728013895

Price per 2 pieces / Prix par 2 pièces

Separation sheets  
• 5 pieces per package

Tôles de séparation  
• 5 pièces par paquet

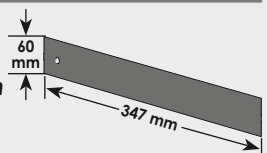

V1390,  
EAN 4047728013901

Price per set (= 5 separation sheets)  
Prix par jeu (= 5 tôles de séparation)

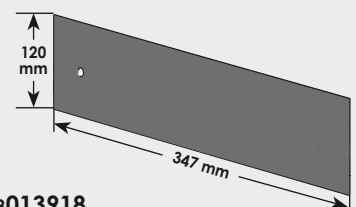

V1391,  
EAN 4047728013918

Price per set (= 5 separation sheets)  
Prix par jeu (= 5 tôles de séparation)



**Tool Trolley / Tool chest VIGOR 1000**  
**Servante d'atelier / Coffre à tiroirs VIGOR 1000**



H 1000 x W 723 x D 459 mm  
 H 1000 x L 723 x P 459 mm

**VIGOR 1000**

VIGOR 1000 with 7 drawers, empty  
 V1901, EAN 4047728019019

VIGOR 1000 avec 7 tiroirs, vide  
 V1901, EAN 4047728019019

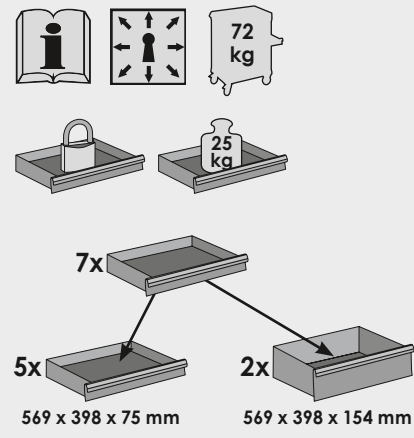

**VIGOR 1000**

Tool chest, empty  
 V1902, EAN 4047728019026  
 Coffre à tiroirs, vide  
 V1902, EAN 4047728019026



H 375 x W 723 x D 459 mm  
 H 375 x L 723 x P 459 mm

- Delivery without plastic worktop, see V1909 /  
 Livraison sans plateau de travail en plastique,  
 voir V1909 -



**Accessory for VIGOR 1000 /  
 Accessoires pour VIGOR 1000**

Plastic worktop  
 V1909, EAN 4047728019095  
 • for tool trolley and tool chest

Plateau de travail en plastique  
 V1909, EAN 4047728019095  
 • pour la servante d'atelier et le coffre à tiroirs



# Tool Trolley VIGOR 1000 / Tool Case Servante d'atelier VIGOR 1000 / Caisse à outils

EQUIPMENT  
**VIGOR**

## VIGOR 1000

VIGOR 1000 Tool Trolley  
with tool chest, empty  
V1970, EAN 4047728019705

VIGOR 1000 Servante d'atelier  
avec coffre à tiroirs, vide  
V1970, EAN 4047728019705

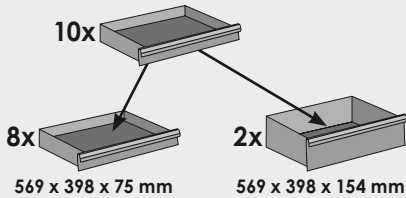
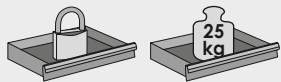

- Delivery without tools and accessories (available on request) /  
Livraison sans outils et accessoires (disponibles sur simple demande) -

Lid organizers  
Compartmentiments  
pour petites  
pièces intégrés



Tool Case  
V1425, EAN 4047728014250

• Internal handle tray with bit-holder  
and measuring scale (cm / inch)

Caisse à outils  
V1425, EAN 4047728014250

• Poignée avec porte-embouts  
et réglet (cm / pouce)



**Double Open-End Wrench Set**  
**Jeu de clés à fourche doubles**  
**V1683, EAN 4047728016834**  
 DIN 3113

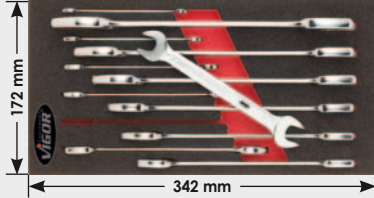

6 x 7 - 30 x 32 mm

**Combination Wrench Set**  
**Jeu de clés mixtes**  
**V1662, EAN 4047728016629**  
 DIN 3113 / ISO 7738

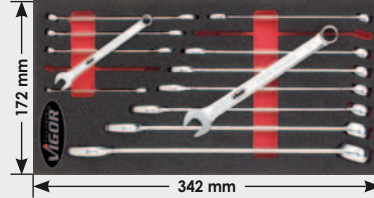

6 - 22 mm

**Ratcheting Combination Wrench Set**  
**Jeu de clés mixtes à cliquet**  
**V1663, EAN 4047728016636**

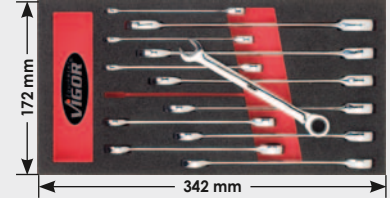

8 - 19 mm

2-component soft foam insert, empty  
 Garniture en mousse souple bimatière, vide  
**V1668, EAN 4047728016681**

2-component soft foam insert, empty  
 Garniture en mousse souple bimatière, vide  
**V1649, EAN 4047728016490**

2-component soft foam insert, empty  
 Garniture en mousse souple bimatière, vide  
**V1651, EAN 4047728016513**

**Screwdriver Set**   
**Jeu de tournevis**   
**V1664, EAN 4047728016643**

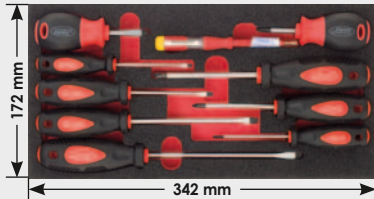

3; 4; 5.5; 6.5 mm  
 PH 0; PH 1; PH 2

**VDE Screwdriver Set**   
**Jeu de tournevis VDE**   
**V2015, EAN 4047728020152**

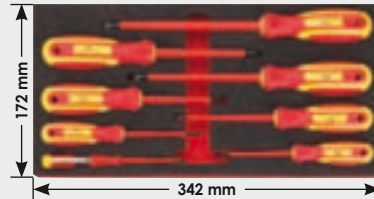

3; 4; 5.5; 6.5 mm  
 PH 0; PH 1; PH 2



1/2 Inside Hexagon Tools   
 1/2 Outils à 6 pans intérieurs   
**V1660, EAN 4047728016605**



SW 5 - SW 10 mm

2-component soft foam insert, empty  
 Garniture en mousse souple bimatière, vide  
**V1655, EAN 4047728016551**

2-component soft foam insert, empty  
 Garniture en mousse souple bimatière, vide  
**V2240, EAN 4047728022408**

2-component soft foam insert, empty  
 Garniture en mousse souple bimatière, vide  
**V1653, EAN 4047728016537**

6.3 1/4 and 1/2 TORX® Tools and   
 1/2 Sockets with Internal Serration (XZN)   
 6.3 1/4 et 1/2 Outils TORX® et   
 1/2 Douilles à denture multiple (XZN)   
**V1519, EAN 4047728015196**

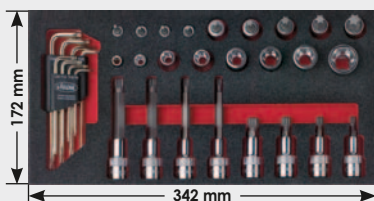

T 15 - T 55  
 E 8 - E 24  
 M 6 - M 12

6.3 1/4 and 1/2 TORX® Tools   
 6.3 1/4 et 1/2 Outils TORX®   
**V1661, EAN 4047728016612**

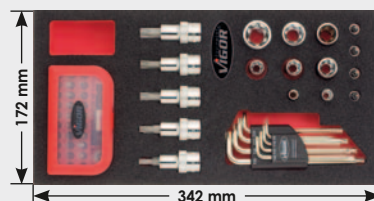

T 15 - T 55  
 E 8 - E 24

2-component soft foam insert, empty  
 Garniture en mousse souple bimatière, vide  
**V1509, EAN 4047728015097**

2-component soft foam insert, empty  
 Garniture en mousse souple bimatière, vide  
**V1654, EAN 4047728016544**

**STURDY ■ STRONG ■ GOOD**  
**PUISSANT ■ ROBUSTE ■ QUALITATIF**

[www.vigor-equipment.com](http://www.vigor-equipment.com)

# 1/3 Soft Foam Inserts for VIGOR 500-800

## 1/3 Garnitures en mousse souple pour VIGOR 500-800

EQUIPMENT  
**VIGOR**

122 1/2 Sockets, long style ●  
122 1/2 Douilles longues ●  
V1658, EAN 4047728016582

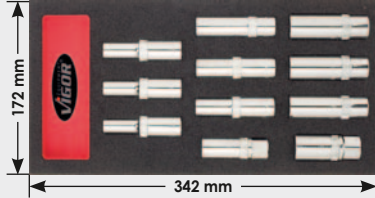

● SW 10 – 19 mm  
● 16; 21 mm

2-component soft foam insert, empty  
Garniture en mousse souple bimatière, vide  
V1652, EAN 4047728016520

10 3/8 Insert Tools ●  
10 3/8 Outils emboîtables ●  
V1485, EAN 4047728014854

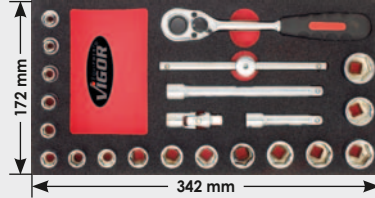

● SW 6 – 22 mm

2-component soft foam insert, empty  
Garniture en mousse souple bimatière, vide  
V1515, EAN 4047728015158

122 1/2 Sockets with Internal Serration (XZN) ○ and Twist Drill Set  
122 1/2 Douilles à denture multiple (XZN) ○ et forets hélicoïdaux  
V1682, EAN 4047728016827

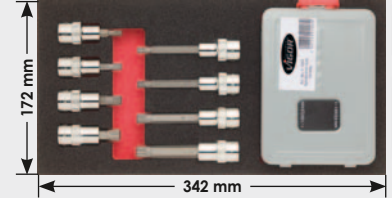

○ M 6 – M 12

2-component soft foam insert, empty  
Garniture en mousse souple bimatière, vide  
V1667, EAN 4047728016674

Twist Drill and Scraper Set  
Jeu de forets hélicoïdaux et grattoirs  
V1522, EAN 4047728015226

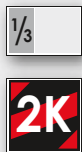

2-component soft foam insert, empty  
Garniture en mousse souple bimatière, vide  
V1512, EAN 4047728015127

Cutter, Scraper and Tweezers Set  
Jeu de couteaux, grattoirs et pincettes  
V1523, EAN 4047728015233



2-component soft foam insert, empty  
Garniture en mousse souple bimatière, vide  
V1514, EAN 4047728015141

Hook and Scraper Set with Car Light Tester  
Jeu de grattoirs et crochets avec testeur d'éclairage auto  
V1746, EAN 4047728017466

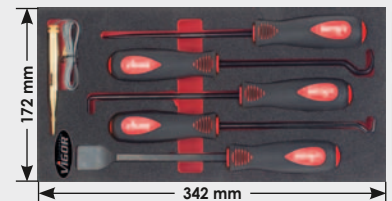

2-component soft foam insert, empty  
Garniture en mousse souple bimatière, vide  
V1745, EAN 4047728017459

Grip Pliers Set  
Jeu de pinces-étaux  
V1729, EAN 4047728017299



2-component soft foam insert, empty  
Garniture en mousse souple bimatière, vide  
V1807, EAN 4047728018074

File Set  
Jeu de limes  
V1811, EAN 4047728018111

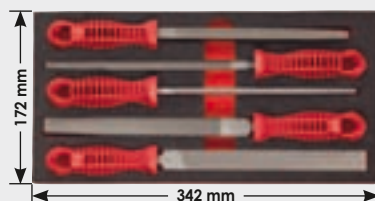

2-component soft foam insert, empty  
Garniture en mousse souple bimatière, vide  
V1806, EAN 4047728018067

2-component soft foam insert, empty  
Garniture en mousse souple bimatière, vide  
V2239, EAN 4047728022392





# 2/3 Soft Foam Inserts for VIGOR 500-800 2/3 Garnitures en mousse souple pour VIGOR 500-800

6.3 1/4 and 12.9 1/2 Insert Tools ●  
6.3 1/4 et 12.9 1/2 Outils emboîtables ●  
V1665, EAN 4047728016650

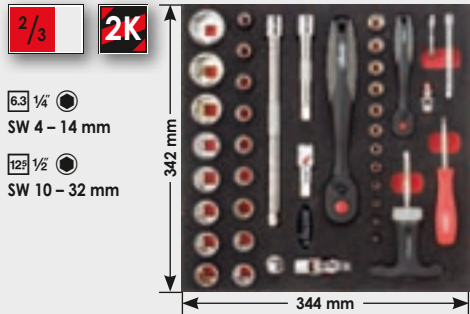

6.3 1/4 ●  
SW 4 - 14 mm  
12.9 1/2 ●  
SW 10 - 32 mm

2-component soft foam insert, empty  
Garniture en mousse souple bimatière, vide  
V1656, EAN 4047728016568

Hammers, Pliers and Chisels  
Marteaux, pinces et burins  
V1521, EAN 4047728015219



2-component soft foam insert, empty  
Garniture en mousse souple bimatière, vide  
V1511, EAN 4047728015110

Screwdriver Set and Bit Box ●⊕  
Jeu de tournevis et assortiment  
d'embouts-tournevis ●⊕  
V1518, EAN 4047728015189

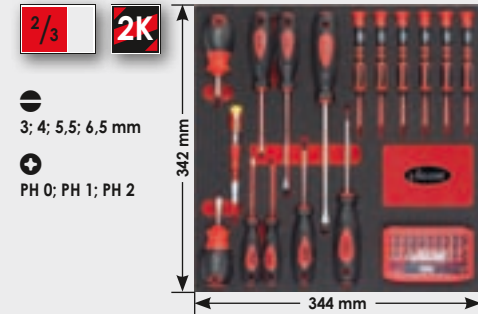

●  
3; 4; 5.5; 6.5 mm  
⊕  
PH 0; PH 1; PH 2

2-component soft foam insert, empty  
Garniture en mousse souple bimatière, vide  
V1507, EAN 4047728015073

12.9 1/2 Screwdriver Socket Set  
for TORX® Screws ●●  
12.9 1/2 Jeu de douilles mâles  
pour vis TORX® ●●  
V2033, EAN 4047728020336

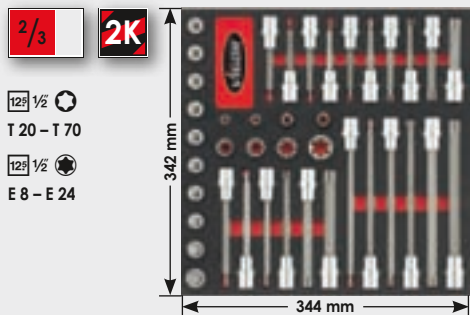

12.9 1/2 ●  
T 20 - T 70  
12.9 1/2 ●  
E 8 - E 24

2-component soft foam insert, empty  
Garniture en mousse souple bimatière, vide  
V2021, EAN 4047728020213

12.9 1/2 Screwdriver Socket Set for  
Screws with Internal Serration XZN ●  
12.9 1/2 Jeu de douilles mâles pour  
vis à denture multiple XZN ●  
V2032, EAN 4047728020329

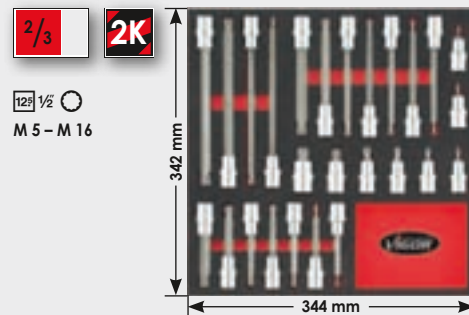

12.9 1/2 ●  
M 5 - M 16

2-component soft foam insert, empty  
Garniture en mousse souple bimatière, vide  
V1900, EAN 4047728019002

12.9 1/2 Screwdriver Socket Set  
for Inside Hexagon Screws ●  
12.9 1/2 Jeu de douilles mâles  
pour vis à 6 pans intérieurs ●  
V2022, EAN 4047728020220

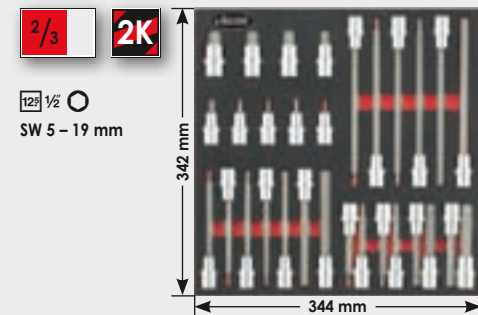

12.9 1/2 ●  
SW 5 - 19 mm

2-component soft foam insert, empty  
Garniture en mousse souple bimatière, vide  
V1899, EAN 4047728018999

12.9 1/2 RIBE Screwdriver Socket Set ●  
12.9 1/2 Jeu de douilles mâles  
à empreinte RIBE ●  
V2258, EAN 4047728022583

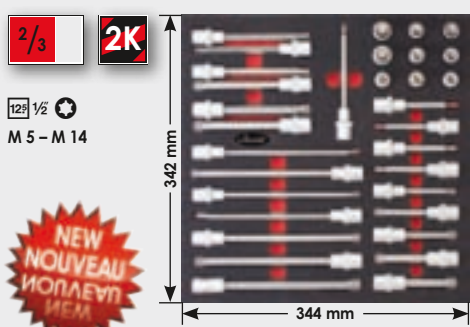

12.9 1/2 ●  
M 5 - M 14



2-component soft foam insert, empty  
Garniture en mousse souple bimatière, vide  
V2259, EAN 4047728022590

20 3/4 Tool Set ●  
20 3/4 Jeu d'outils ●  
V2364, EAN 4047728023641

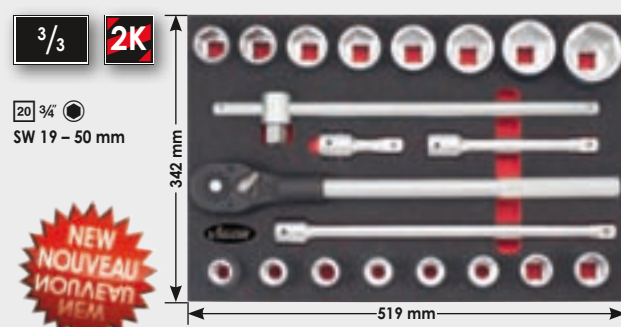

20 3/4 ●  
SW 19 - 50 mm



2-component soft foam insert, empty  
Garniture en mousse souple bimatière, vide  
V2363, EAN 4047728023634



Available from August 2011  
Livable à partir du mois d'août 2011



# 3/3 Soft Foam Inserts for VIGOR 500-800

## 3/3 Garnitures en mousse souple pour VIGOR 500-800



6.3 1/4 and 12.2 1/2 Insert Tools and 12.2 1/2 Inside Hexagon Tools  
 6.3 1/4 et 12.2 1/2 outils emboîtables et 12.2 1/2 outils à 6 pans intérieurs

V1516, EAN 4047728015165



3/3 2K

6.3 1/4 SW 4 - 14 mm

12.2 1/2 SW 10 - 32 mm

12.2 1/2 SW 5 - 10 mm

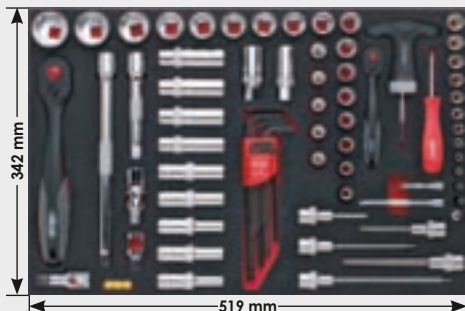

2-component soft foam insert, empty  
 Garniture en mousse souple bimatière, vide  
 V1505, EAN 4047728015059

Ratcheting Combination Wrenches and 15° Offset Combination Wrenches  
 Clés mixtes à cliquet et clés mixtes coudées à 15°

V1517, EAN 4047728015172



3/3 2K

SW 8 - 19 mm

SW 6 - 22 mm

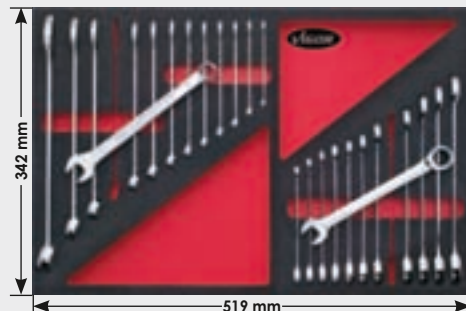

2-component soft foam insert, empty  
 Garniture en mousse souple bimatière, vide  
 V1506, EAN 4047728015066

Double Box Wrench and Double Open-End Wrench Set  
 Jeu de clés polygonales et de clés à fourche

V1525, EAN 4047728015257



3/3 2K

SW 6 x 7 - 30 x 32 mm

SW 6 x 7 - 30 x 32 mm

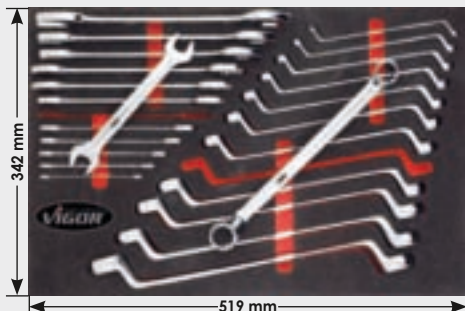

2-component soft foam insert, empty  
 Garniture en mousse souple bimatière, vide  
 V1513, EAN 4047728015134

Ratcheting Combination Wrenches, Ratcheting Aluminium Box Wrenches and 15° Offset Combination Wrenches  
 Clés mixtes à cliquet, clés polygonales à cliquet en aluminium et clés mixtes coudées à 15°

V1747, EAN 4047728017473



3/3 2K

SW 8 - 19 mm

SW 8 - 19 mm

SW 6 - 22 mm

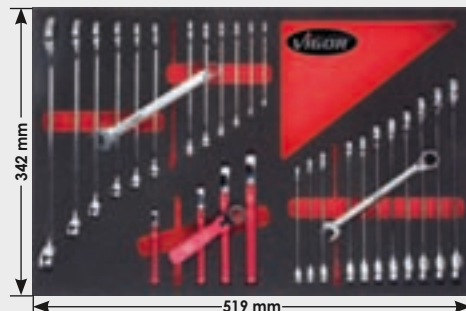

2-component soft foam insert, empty  
 Garniture en mousse souple bimatière, vide  
 V1743, EAN 4047728017435

TORX® and 6-Point T-Handle Screwdriver Set  
 Jeu de tournevis avec manche en T, TORX® et 6 pans

V1520, EAN 4047728015202



3/3 2K

T 9; T 10; T 15; T 20; T 25; T 27; T 30; T 40

2; 2.5; 3; 4; 5; 6; 8; 10 mm

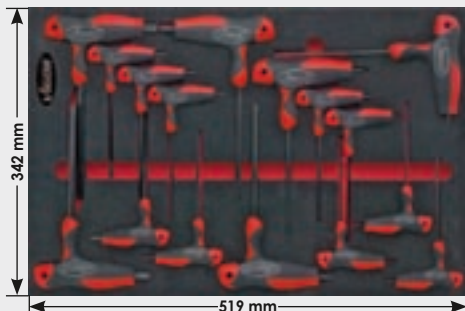

2-component soft foam insert, empty  
 Garniture en mousse souple bimatière, vide  
 V1510, EAN 4047728015103

Measuring and Cutting Tools, Pliers  
 Outils de mesurage, outils coupants et pinces

V1748, EAN 4047728017480



3/3 2K



2-component soft foam insert, empty  
 Garniture en mousse souple bimatière, vide  
 V1871, EAN 4047728018715

**6.3 1/4 10 3/8 12.5 1/2 Socket Set**  
**6.3 1/4 10 3/8 12.5 1/2 Jeu de clés à douilles**

V2005, EAN 4047728020053



V1000 1/1 **2K**

- 6.3 1/4 ● SW 4 – 14 mm
- 10 3/8 ● SW 6 – 21 mm
- 12.5 1/2 ● SW 10 – 32 mm



2-component soft foam insert, empty  
 Garniture en mousse souple bimatière, vide  
 V1971, EAN 4047728019712

**TORX® and 6-Point T-Handle Screwdriver Set**  
**Jeu de tournevis avec manche en T, TORX® et 6 pans**

V2006, EAN 4047728020060



V1000 1/1 **2K**

- ⊕ T 9; T 10; T 15; T 20;  
T 25; T 27; T 30; T 40
- 2; 2.5; 3; 4; 5;  
6; 8; 10 mm

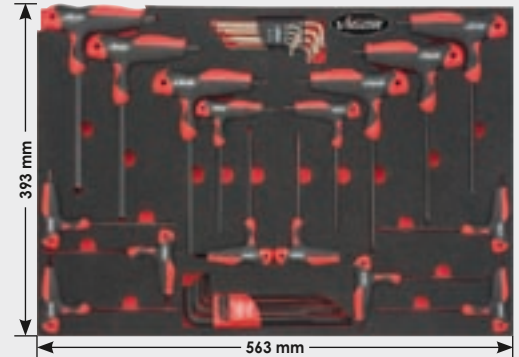

2-component soft foam insert, empty  
 Garniture en mousse souple bimatière, vide  
 V1972, EAN 4047728019729

**Scraper and Screwdriver Set**  
**Jeu de grattoirs et tournevis**

V2007, EAN 4047728020077



V1000 1/1 **2K**

- 3; 4; 5.5; 6.5 mm
- ⊕ PH 0; PH 1; PH 2

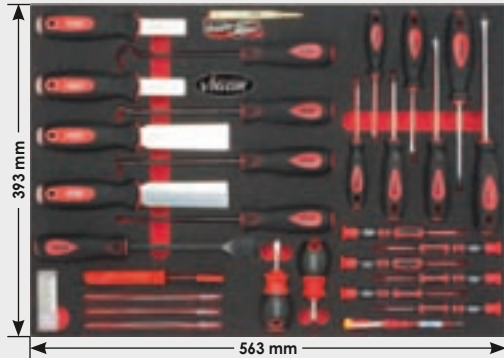

2-component soft foam insert, empty  
 Garniture en mousse souple bimatière, vide  
 V1973, EAN 4047728019736

**Double Box Wrench, Double Open-End Wrench and Combination Wrench Set**  
**Jeu de clés polygonales, clés à fourche et clés mixtes**

V2008, EAN 4047728020084



V1000 1/1 **2K**

- ⊕ SW 6 x 7 – 21 x 23 mm
- ⊕ SW 6 – 27 mm
- ⊕ SW 6 x 7 – 24 x 27 mm

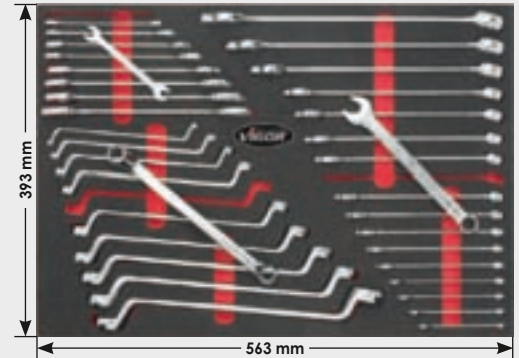

2-component soft foam insert, empty  
 Garniture en mousse souple bimatière, vide  
 V1974, EAN 4047728019743

**Pliers, Hammers, and Chisels Set**  
**Jeu de pinces, marteaux et burins**

V2009, EAN 4047728020091



V1000 1/1 **2K**



2-component soft foam insert, empty  
 Garniture en mousse souple bimatière, vide  
 V1975, EAN 4047728019750

**Adapter Inserts and dimension illustration**  
**Garnitures d'adaptation et illustration des dimensions**

V2237, EAN 4047728022378

44 x 342 mm

V2238, EAN 4047728022385

563 x 51 mm

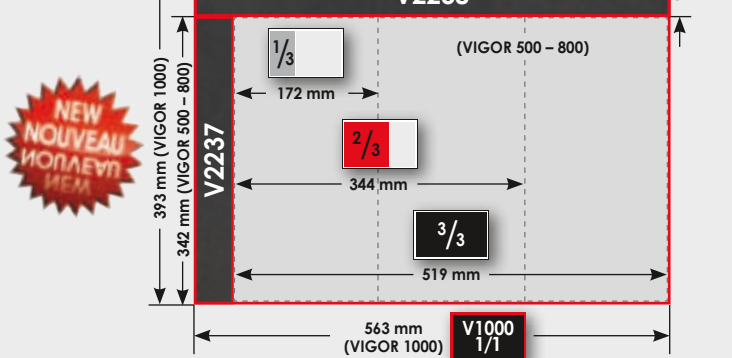

**V2237, EAN 4047728022378**  
 44 x 342 mm

**V2238, EAN 4047728022385**  
 563 x 51 mm

# Socket Systems $6.3 \frac{1}{4}$ Systèmes de douilles $6.3 \frac{1}{4}$

EQUIPMENT  
**VIGOR**



$6.3 \frac{1}{4}$  Socket Set  
V1094, EAN 4047728010948

$6.3 \frac{1}{4}$  Jeu de clés à douilles  
V1094, EAN 4047728010948

VIGOR No.	■	Contents Contenu	Sizes Dimensions mm	EAN 4047728+
V1055	$6.3 \frac{1}{4}$		4	010559
V1056	$6.3 \frac{1}{4}$		5	010566
V1057	$6.3 \frac{1}{4}$		5,5	010573
V1058	$6.3 \frac{1}{4}$		6	010580
V1059	$6.3 \frac{1}{4}$		7	010597
V1060	$6.3 \frac{1}{4}$		8	010603
V1061	$6.3 \frac{1}{4}$		9	010610
V1062	$6.3 \frac{1}{4}$		10	010627
V1063	$6.3 \frac{1}{4}$		11	010634
V1064	$6.3 \frac{1}{4}$		12	010641
V1065	$6.3 \frac{1}{4}$		13	010658
V1066	$6.3 \frac{1}{4}$		14	010665

$6.3 \frac{1}{4}$  Socket Set  
with Multi-Purpose Profile  
V1897, EAN 4047728018975

$6.3 \frac{1}{4}$

$6.3 \frac{1}{4}$  Jeu de douilles  
à profil de multifonction  
V1897, EAN 4047728018975

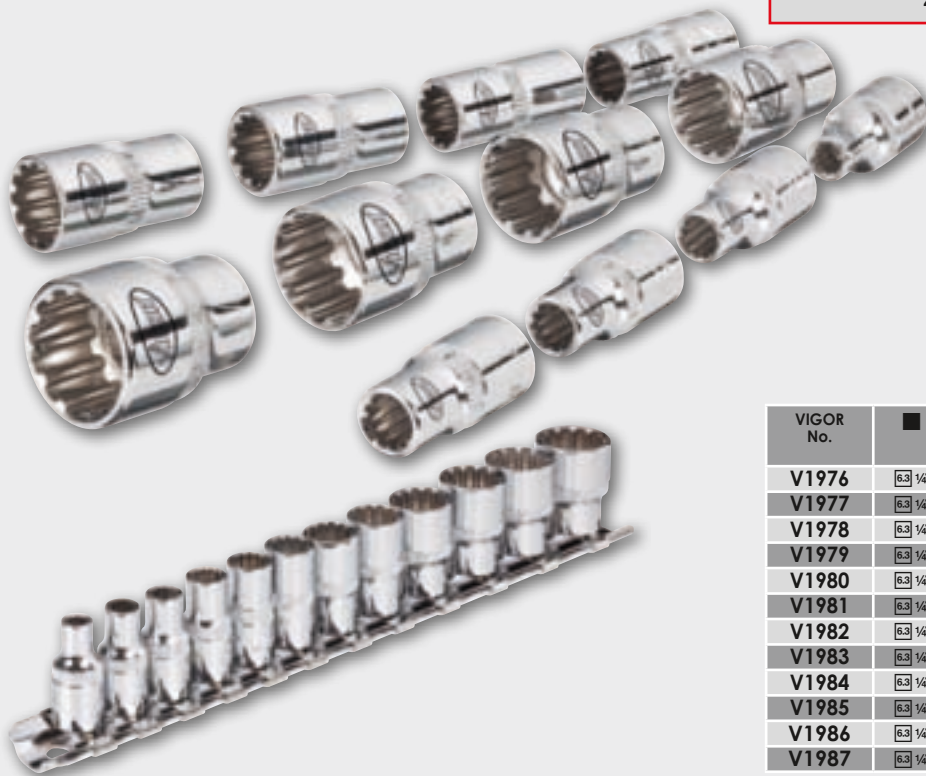

## Multifunction screw profiles Profils de multifonction

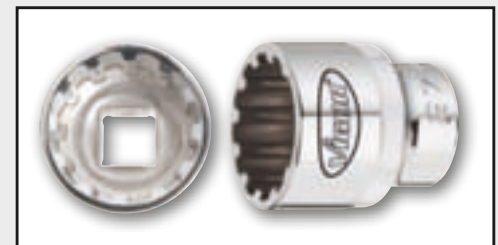
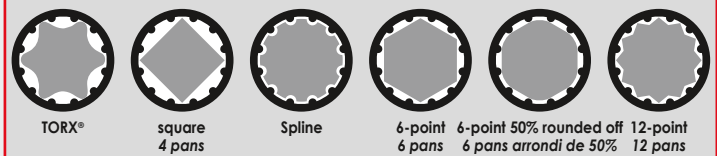

VIGOR No.	■	Contents Contenu	Sizes Dimensions mm	EAN 4047728+
V1067	$6.3 \frac{1}{4}$	L = 50 mm	-	010672
V1068	$6.3 \frac{1}{4}$	L = 100 mm	-	010689
V1038	$6.3 \frac{1}{4}$	L = 150 mm	-	010382
V1032	$6.3 \frac{1}{4}$	* L = 150 mm	$\frac{1}{4}$ "- $\frac{1}{4}$ "	010320
V1069	$6.3 \frac{1}{4}$		35	010696
V1071	$6.3 \frac{1}{4}$	PH 1	25	010719
V1072	$6.3 \frac{1}{4}$	PH 2	25	010726
V1073	$6.3 \frac{1}{4}$	PH 3	25	010733
V1074	$6.3 \frac{1}{4}$	PZ 1	25	010740
V1075	$6.3 \frac{1}{4}$	PZ 2	25	010757
V1076	$6.3 \frac{1}{4}$	PZ 3	25	010764
V1077	$6.3 \frac{1}{4}$	4,0 x 0,8 mm	25	010771
V1078	$6.3 \frac{1}{4}$	5,5 x 1,0 mm	25	010788
V1079	$6.3 \frac{1}{4}$	6,5 x 1,2 mm	25	010795
V1080	$6.3 \frac{1}{4}$	3 mm	25	010801
V1081	$6.3 \frac{1}{4}$	4 mm	25	010818
V1082	$6.3 \frac{1}{4}$	5 mm	25	010825
V1095	$6.3 \frac{1}{4}$	6 mm	25	010955
V1083	$6.3 \frac{1}{4}$	TORX® T 10 H	25	010832
V1084	$6.3 \frac{1}{4}$	TORX® T 15 H	25	010849
V1085	$6.3 \frac{1}{4}$	TORX® T 20 H	25	010856
V1086	$6.3 \frac{1}{4}$	TORX® T 25 H	25	010863
V1087	$6.3 \frac{1}{4}$	TORX® T 15	25	010870
V1088	$6.3 \frac{1}{4}$	TORX® T 20	25	010887
V1089	$6.3 \frac{1}{4}$	TORX® T 25	25	010894
V1090	$6.3 \frac{1}{4}$	TORX® T 27	25	010900
V1091	$6.3 \frac{1}{4}$	TORX® T 30	25	010917
V1092	$6.3 \frac{1}{4}$	TORX® T 40	25	010924
V1093	$6.3 \frac{1}{4}$	$6.3 \frac{1}{4}$ - $6.3 \frac{1}{4}$	25	010931

VIGOR No.	■	Contents Contenu	Sizes Dimensions mm	L mm	EAN 4047728+
V1976	$6.3 \frac{1}{4}$		4	25	019767
V1977	$6.3 \frac{1}{4}$		5	25	019774
V1978	$6.3 \frac{1}{4}$		5,5	25	019781
V1979	$6.3 \frac{1}{4}$		6	25	019798
V1980	$6.3 \frac{1}{4}$		7	25	019804
V1981	$6.3 \frac{1}{4}$		8	25	019811
V1982	$6.3 \frac{1}{4}$		9	25	019828
V1983	$6.3 \frac{1}{4}$		10	25	019835
V1984	$6.3 \frac{1}{4}$		11	25	019842
V1985	$6.3 \frac{1}{4}$		12	25	019859
V1986	$6.3 \frac{1}{4}$		13	25	019866
V1987	$6.3 \frac{1}{4}$		14	25	019873



6.3 1/4 Socket Set  
V2305, EAN 4047728023054

10 3/8"

6.3 1/4 Jeu de clés à douilles  
V2305, EAN 4047728023054



**Available from August 2011**  
**Livrable à partir du**  
**mois d'août 2011**



10 3/8 Flexible Extension  
V2371, EAN 4047728023719

10 3/8"

• Max. 80 Nm

10 3/8 Rallonge flexible  
V2371, EAN 4047728023719

• Max. 80 Nm

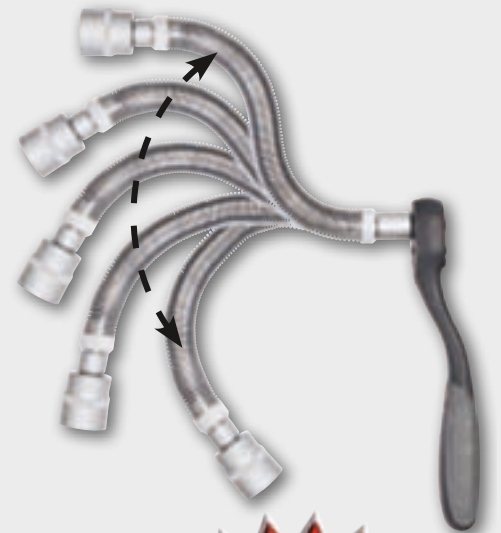

# Socket Systems $12\frac{5}{8}$ Systèmes de douilles $12\frac{5}{8}$

EQUIPMENT  
**VIGOR**



Extension with LED light  
- see below V1131 -  
Rallonge avec lampe LED  
- voir V1131 ci-dessous -



$12\frac{5}{8}$  Socket Set  
V1132, EAN 4047728011327

$12\frac{5}{8}$  Jeu de clés à douilles  
V1132, EAN 4047728011327

$12\frac{5}{8}$

VIGOR No.	■	Contents Contenu	Sizes Dimensions mm	EAN 4047728+
V1098	$12\frac{5}{8}$		10	010986
V1099	$12\frac{5}{8}$		11	010993
V1100	$12\frac{5}{8}$		12	011006
V1101	$12\frac{5}{8}$		13	011013
V1102	$12\frac{5}{8}$		14	011020
V1103	$12\frac{5}{8}$		15	011037

VIGOR No.	■	Contents Contenu	Sizes Dimensions mm	EAN 4047728+
V1104	$12\frac{5}{8}$		16	011044
V1105	$12\frac{5}{8}$		17	011051
V1106	$12\frac{5}{8}$		18	011068
V1107	$12\frac{5}{8}$		19	011075
V1108	$12\frac{5}{8}$		20	011082
V1109	$12\frac{5}{8}$		21	011099
V1110	$12\frac{5}{8}$		22	011105
V1111	$12\frac{5}{8}$		24	011112
V1112	$12\frac{5}{8}$		27	011129
V1113	$12\frac{5}{8}$		30	011136
V1114	$12\frac{5}{8}$		32	011143
V1115	$12\frac{5}{8}$		10	011150
V1116	$12\frac{5}{8}$		11	011167
V1117	$12\frac{5}{8}$		12	011174
V1118	$12\frac{5}{8}$		13	011181
V1119	$12\frac{5}{8}$		14	011198
V1120	$12\frac{5}{8}$		15	011204
V1121	$12\frac{5}{8}$		17	011211
V1122	$12\frac{5}{8}$		18	011228
V1123	$12\frac{5}{8}$		19	011235
V1124	$12\frac{5}{8}$	L = 125 mm	-	011242
V1125	$12\frac{5}{8}$	L = 250 mm	-	011259
V1126	$12\frac{5}{8}$		70	011266
V1127	$12\frac{5}{8}$		16	011273
V1128	$12\frac{5}{8}$		21	011280
V1129	$12\frac{5}{8}$	$10\frac{3}{8}$ - $12\frac{5}{8}$	-	011297
V1131	$12\frac{5}{8}$	+  1,5 V (LR 44) - 180 mAh	60	011310
V1020	$12\frac{5}{8}$	L = 250 mm	-	010207

$12\frac{5}{8}$  Socket Set  
with Multi-Purpose Profile  
V1898, EAN 4047728018982

$12\frac{5}{8}$



$12\frac{5}{8}$  Jeu de douilles  
à profil de multifonction  
V1898, EAN 4047728018982

## Multifunction screw profiles Profils de multifonction

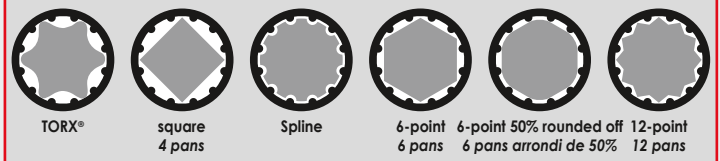

VIGOR No.	■	Contents Contenu	Sizes Dimensions mm	L mm	EAN 4047728+
V1988	$12\frac{5}{8}$		10	38	019880
V1989	$12\frac{5}{8}$		11	38	019897
V1990	$12\frac{5}{8}$		12	38	019903
V1991	$12\frac{5}{8}$		13	38	019910
V1992	$12\frac{5}{8}$		14	38	019927
V1993	$12\frac{5}{8}$		15	38	019934
V1994	$12\frac{5}{8}$		16	38	019941
V1995	$12\frac{5}{8}$		17	38	019958
V1996	$12\frac{5}{8}$		18	38	019965
V1997	$12\frac{5}{8}$		19	38	019972
V1998	$12\frac{5}{8}$		20	38	019989
V1999	$12\frac{5}{8}$		21	38	019996
V2000	$12\frac{5}{8}$		22	38	020008
V2001	$12\frac{5}{8}$		24	40	020015
V2002	$12\frac{5}{8}$		27	42	020022
V2003	$12\frac{5}{8}$		30	45	020039
V2004	$12\frac{5}{8}$		32	45	020046

$12\frac{5}{16}$ " Screwdriver Socket Set  
for Screws with Internal Serration  
XZN ○



























$12\frac{5}{16}$ " 



$12\frac{5}{16}$ " Jeu de douilles mâles  
pour vis à denture multiple XZN ○

V1918, EAN 4047728019187



VIGOR No.		Contents Contenu	Sizes Dimensions mm	L mm	EAN 4047728+
V2094	$12\frac{5}{16}$ "		M5	55	020947
V2095	$12\frac{5}{16}$ "		M6	55	020954
V2096	$12\frac{5}{16}$ "		M8	55	020961
V2097	$12\frac{5}{16}$ "		M9	55	020978
V2098	$12\frac{5}{16}$ "		M10	55	020985
V2099	$12\frac{5}{16}$ "		M12	55	020992
V2065	$12\frac{5}{16}$ "		M14	55	020657
V2100	$12\frac{5}{16}$ "		M16	55	021005
V2066	$12\frac{5}{16}$ "		M5	100	020664
V2068	$12\frac{5}{16}$ "		M6	100	020688
V2067	$12\frac{5}{16}$ "		M8	100	020671
V2113	$12\frac{5}{16}$ "		M9	100	021135
V2059	$12\frac{5}{16}$ "		M10	100	020596
V2060	$12\frac{5}{16}$ "		M12	100	020602
V2121	$12\frac{5}{16}$ "		M14	100	021210
V2122	$12\frac{5}{16}$ "		M5	140	021227
V2124	$12\frac{5}{16}$ "		M6	140	021241
V2123	$12\frac{5}{16}$ "		M8	140	021234
V2126	$12\frac{5}{16}$ "		M9	140	021265
V2128	$12\frac{5}{16}$ "		M10	140	021289
V2129	$12\frac{5}{16}$ "		M12	140	021296
V2132	$12\frac{5}{16}$ "		M14	140	021326
V2133	$12\frac{5}{16}$ "		M8	200	021333
V2134	$12\frac{5}{16}$ "		M10	200	021340
V2135	$12\frac{5}{16}$ "		M12	200	021357
V2137	$12\frac{5}{16}$ "		M14	200	021371

$12\frac{5}{16}$ " Screwdriver Socket Set  
for Inside Hexagon Screws ○































$12\frac{5}{16}$ " 



$12\frac{5}{16}$ " Jeu de douilles mâles  
pour vis à 6 pans intérieurs ○

V1919, EAN 4047728019194



VIGOR No.		Contents Contenu	Sizes Dimensions mm	L mm	EAN 4047728+
V2101	$12\frac{5}{16}$ "		5	55	021012
V2102	$12\frac{5}{16}$ "		6	55	021029
V2103	$12\frac{5}{16}$ "		7	55	021036
V2104	$12\frac{5}{16}$ "		8	55	021043
V2105	$12\frac{5}{16}$ "		10	55	021050
V2106	$12\frac{5}{16}$ "		12	55	021067
V2107	$12\frac{5}{16}$ "		14	55	021074
V2069	$12\frac{5}{16}$ "		17	55	020695
V2070	$12\frac{5}{16}$ "		19	55	020701
V2072	$12\frac{5}{16}$ "		5	100	020725
V2073	$12\frac{5}{16}$ "		6	100	020732
V2074	$12\frac{5}{16}$ "		7	100	020749
V2075	$12\frac{5}{16}$ "		8	100	020756
V2076	$12\frac{5}{16}$ "		10	100	020763
V2077	$12\frac{5}{16}$ "		11	100	020770
V2078	$12\frac{5}{16}$ "		12	100	020787
V2079	$12\frac{5}{16}$ "		13	100	020794
V2080	$12\frac{5}{16}$ "		5	140	020800
V2081	$12\frac{5}{16}$ "		6	140	020817
V2082	$12\frac{5}{16}$ "		7	140	020824
V2083	$12\frac{5}{16}$ "		8	140	020831
V2084	$12\frac{5}{16}$ "		10	140	020848
V2085	$12\frac{5}{16}$ "		12	140	020855
V2086	$12\frac{5}{16}$ "		14	140	020862
V2087	$12\frac{5}{16}$ "		5	200	020879
V2088	$12\frac{5}{16}$ "		6	200	020886
V2089	$12\frac{5}{16}$ "		7	200	020893
V2090	$12\frac{5}{16}$ "		8	200	020909
V2091	$12\frac{5}{16}$ "		10	200	020916
V2092	$12\frac{5}{16}$ "		12	200	020923

# Socket Systems $12\frac{5}{16}$ " Systèmes de douilles $12\frac{5}{16}$ "

EQUIPMENT  
**VIGOR**































$12\frac{5}{16}$ " RIBE Screwdriver Socket Set   
V2201, EAN 4047728022019

$12\frac{5}{16}$ "



$12\frac{5}{16}$ " Jeu de douilles mâles à empreinte RIBE   
V2201, EAN 4047728022019

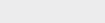
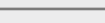
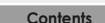

VIGOR No.		Contents Contenu	Sizes Dimensions mm	L mm	EAN 4047728+
V2202	$12\frac{5}{16}$ "		M5	55	022026
V2203	$12\frac{5}{16}$ "		M6	55	022033
V2204	$12\frac{5}{16}$ "		M7	55	022040
V2205	$12\frac{5}{16}$ "		M8	55	022057
V2206	$12\frac{5}{16}$ "		M9	55	022064
V2207	$12\frac{5}{16}$ "		M10	55	022071
V2208	$12\frac{5}{16}$ "		M12	55	022088
V2209	$12\frac{5}{16}$ "		M13	55	022095
V2210	$12\frac{5}{16}$ "		M14	55	022101
V2211	$12\frac{5}{16}$ "		M5	100	022118
V2212	$12\frac{5}{16}$ "		M6	100	022125
V2213	$12\frac{5}{16}$ "		M7	100	022132
V2214	$12\frac{5}{16}$ "		M8	100	022149
V2215	$12\frac{5}{16}$ "		M9	100	022156
V2216	$12\frac{5}{16}$ "		M10	100	022163
V2217	$12\frac{5}{16}$ "		M12	100	022170
V2218	$12\frac{5}{16}$ "		M13	100	022187
V2219	$12\frac{5}{16}$ "		M14	100	022194
V2220	$12\frac{5}{16}$ "		M8	140	022200
V2221	$12\frac{5}{16}$ "		M9	140	022217
V2222	$12\frac{5}{16}$ "		M10	140	022224
V2223	$12\frac{5}{16}$ "		M10,3	140	022231
V2224	$12\frac{5}{16}$ "		M12	140	022248
V2225	$12\frac{5}{16}$ "		M13	140	022255
V2226	$12\frac{5}{16}$ "		M14	140	022262
V2227	$12\frac{5}{16}$ "		M8	200	022279
V2228	$12\frac{5}{16}$ "		M9	200	022286
V2229	$12\frac{5}{16}$ "		M10	200	022293
V2230	$12\frac{5}{16}$ "		M10,3	200	022309
V2231	$12\frac{5}{16}$ "		M12	200	022316
V2232	$12\frac{5}{16}$ "		M13	200	022323
V2233	$12\frac{5}{16}$ "		M14	200	022330



















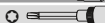







$12\frac{5}{16}$ " TORX® Screwdriver Socket Set   
V1917, EAN 4047728019170

$12\frac{5}{16}$ "



$12\frac{5}{16}$ " Jeu de douilles mâles TORX®   
V1917, EAN 4047728019170

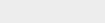
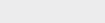
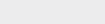
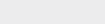
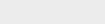
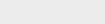

VIGOR No.		Contents Contenu	Sizes Dimensions mm	L mm	EAN 4047728+
V2151	$12\frac{5}{16}$ "		T 20	55	021517
V2152	$12\frac{5}{16}$ "		T 25	55	021524
V2153	$12\frac{5}{16}$ "		T 27	55	021531
V2154	$12\frac{5}{16}$ "		T 30	55	021548
V2155	$12\frac{5}{16}$ "		T 40	55	021555
V2156	$12\frac{5}{16}$ "		T 45	55	021562
V2157	$12\frac{5}{16}$ "		T 50	55	021579
V2158	$12\frac{5}{16}$ "		T 55	55	021586
V2159	$12\frac{5}{16}$ "		T 60	55	021593
V2160	$12\frac{5}{16}$ "		T 70	55	021609
V2161	$12\frac{5}{16}$ "		T 20	100	021616
V2162	$12\frac{5}{16}$ "		T 25	100	021623
V2163	$12\frac{5}{16}$ "		T 27	100	021630
V2165	$12\frac{5}{16}$ "		T 30	100	021654
V2167	$12\frac{5}{16}$ "		T 40	100	021678
V2168	$12\frac{5}{16}$ "		T 45	100	021685
V2169	$12\frac{5}{16}$ "		T 50	100	021692
V2170	$12\frac{5}{16}$ "		T 55	100	021708
V2171	$12\frac{5}{16}$ "		T 60	100	021715
V2172	$12\frac{5}{16}$ "		T 70	100	021722
V2173	$12\frac{5}{16}$ "		T 40	140	021739
V2174	$12\frac{5}{16}$ "		T 45	140	021746
V2175	$12\frac{5}{16}$ "		T 50	140	021753
V2176	$12\frac{5}{16}$ "		T 55	140	021760
V2177	$12\frac{5}{16}$ "		T 60	140	021777
V2178	$12\frac{5}{16}$ "		T 70	140	021784
V2179	$12\frac{5}{16}$ "		T 40	200	021791
V2180	$12\frac{5}{16}$ "		T 45	200	021807
V2181	$12\frac{5}{16}$ "		T 50	200	021814
V2182	$12\frac{5}{16}$ "		T 55	200	021821
V2183	$12\frac{5}{16}$ "		T 60	200	021838
V2184	$12\frac{5}{16}$ "		T 70	200	021845



20 3/4" Socket Set  
 V2318, EAN 4047728023184

25 1/2" Jeu de clés à douilles  
 V2318, EAN 4047728023184

20 3/4"



**NEW**  
**NOUVEAU**  
**NOUVEAU**  
**MEM**

Available from August 2011  
 Livrable à partir du  
 mois d'août 2011



VIGOR No.	■	Contents Contenu	Sizes Dimensions mm	EAN 4047728+	VIGOR No.	■	Contents Contenu	Sizes Dimensions mm	EAN 4047728+	VIGOR No.	■	Contents Contenu	EAN 4047728+
V2323	20 3/4"		19	023238	V2330	20 3/4"		30	023306	V2319	20 3/4"	fine-tooth - à denture fine	023191
V2324	20 3/4"		21	023245	V2331	20 3/4"		32	023313	V2320	20 3/4"	L = 100 mm	023207
V2325	20 3/4"		22	023252	V2332	20 3/4"		34	023320	V2321	20 3/4"	L = 200 mm	023214
V2326	20 3/4"		23	023269	V2333	20 3/4"		36	023337	V2317	20 3/4"	L = 400 mm	023177
V2327	20 3/4"		24	023276	V2334	20 3/4"		38	023344	V2322	20 3/4"	L = 450 mm	023221
V2328	20 3/4"		26	023283	V2337	20 3/4"		41	023375				
V2329	20 3/4"		27	023290	V2336	20 3/4"		46	023368				
V2256	20 3/4"		28	022569	V2335	20 3/4"		50	023351				

**STURDY ■ STRONG ■ GOOD**



[www.vigor-equipment.com](http://www.vigor-equipment.com)

**PUISSANT ■ ROBUSTE ■ QUALITATIF**



[www.vigor-equipment.com](http://www.vigor-equipment.com)



# Socket Systems Systèmes de douilles

EQUIPMENT  
**VIGOR**



6.3 1/4 12.5 1/2 Socket Set  
V1706, EAN 4047728017060

6.3 1/4 12.5 1/2 Jeu de clés à douilles  
V1706, EAN 4047728017060

6.3 1/4 12.5 1/2



■	Contents / Contenu	Sizes / Dimensions mm
6.3 1/4	13 x	4; 4.5; 5; 5.5; 6; 7; 8; 9; 10; 11; 12; 13; 14
6.3 1/4	8 x	6; 7; 8; 9; 10; 11; 12; 13
6.3 1/4	1 x	L = 150
6.3 1/4	2 x	L = 50; 100

■	Contents / Contenu	Sizes / Dimensions mm
6.3 1/4	1 x	L = 110
6.3 1/4	1 x	mat chrome-plated chromé mat
6.3 1/4	1 x	fine-tooth - à denture fine
12.5 1/2	17 x	10; 11; 12; 13; 14; 15; 16; 17; 18; 19; 20; 21; 22; 24; 27; 30; 32

■	Contents / Contenu	Sizes / Dimensions mm
12.5 1/2	5 x	14; 15; 17; 19; 22 mm
12.5 1/2	2 x	16; 21 mm
12.5 1/2	1 x	
12.5 1/2	1 x	L = 125 mm
12.5 1/2	1 x	L = 250 mm
12.5 1/2	1 x	mat chrome-plated chromé mat
12.5 1/2	1 x	fine-tooth - à denture fine
6.3 1/4	3 x	4,0 x 0,8; 5,5 x 1,0; 6,5 x 1,2 mm
6.3 1/4	2 x	PH 1; PH 2
6.3 1/4	2 x	PZ 1; PZ 2
6.3 1/4	4 x	3; 4; 5; 6 mm
6.3 1/4	7 x	TORX® T 8; T 10; T 15; T 20; T 25; T 27; T 30
6.3 1/4	3 x	8,0 x 1,4; 10,0 x 1,8; 12,0 x 2,0 mm
6.3 1/4	2 x	PH 3; PH 4
6.3 1/4	2 x	PZ 3; PZ 4
6.3 1/4	5 x	7; 8; 10; 12; 14 mm
6.3 1/4	5 x	T 40; T 45; T 50; T 55; T 60
6.3 1/4	3 x	Set - Jeu 1,5; 2; 3 mm



6.3 1/4 10 3/8 12.5 1/2 TORX® Socket Set  
V1781, EAN 4047728017817

6.3 1/4 10 3/8 12.5 1/2 Jeu de clés à douilles TORX®  
V1781, EAN 4047728017817

6.3 1/4 10 3/8 12.5 1/2



VIGOR No.	■	Contents Contenu	Sizes / Dimensions mm	EAN 4047728+
V2185	6.3 1/4		E 4	021852
V2186	6.3 1/4		E 5	021869
V2187	6.3 1/4		E 6	021876
V2188	6.3 1/4		E 7	021883
V2189	6.3 1/4		E 8	021890
V2192	6.3 1/4		T 8	021920

VIGOR No.	■	Contents Contenu	Sizes / Dimensions mm	EAN 4047728+
V2190	6.3 1/4		T 10	021906
V2191	6.3 1/4		T 15	021913
V2125	6.3 1/4		T 20	021258
V2127	6.3 1/4		T 25	021272
V2130	6.3 1/4		T 27	021302
V2131	6.3 1/4		T 30	021319

VIGOR No.	■	Contents Contenu	Sizes / Dimensions mm	EAN 4047728+
V2136	6.3 1/4		T 10 H	021364
V2138	6.3 1/4		T 15 H	021388
V2139	6.3 1/4		T 20 H	021395
V2140	6.3 1/4		T 25 H	021401
V2141	6.3 1/4		T 27 H	021418
V2142	6.3 1/4		T 30 H	021425
V2143	10 3/8		E 10	021432
V2144	10 3/8		E 12	021449
V2145	10 3/8		E 14	021456
V2146	10 3/8		E 16	021463
V2147	10 3/8		T 40	021470
V2148	10 3/8		T 45	021487
V2149	10 3/8		T 47	021494
V2150	10 3/8		T 50	021500
V2193	10 3/8		T 40 H	021937
V2194	10 3/8		T 45 H	021944
V2195	10 3/8		T 50 H	021951
V2196	12.5 1/2		E 18	021968
V2197	12.5 1/2		E 20	021975
V2198	12.5 1/2		T 55	021982
V2199	12.5 1/2		T 60	021999
V2200	12.5 1/2		T 55 H	022002

Fine-Tooth Reversible Ratchet Set  
V1039, EAN 4047728010399  
• DIN 3122 / ISO 3315

Jeu de cliquets réversibles à denture fine  
V1039, EAN 4047728010399  
• DIN 3122 / ISO 3315

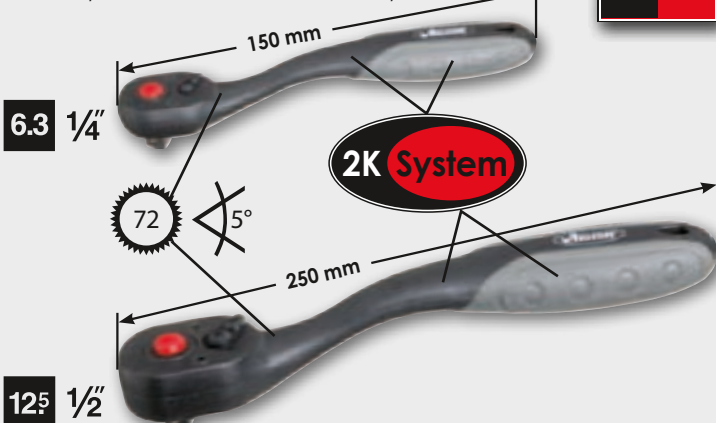

Adapter Set  
V1293, EAN 4047728012935

Jeu d'adaptateurs  
V1293, EAN 4047728012935



VIGOR No.	Contents Contenu	EAN 4047728+
V2014	6.3 1/4 - 10 3/8	020145
V2071	10 3/8 - 6.3 1/4	020718
V2108	10 3/8 - 12.5 1/2	021081

VIGOR No.	Contents Contenu	EAN 4047728+
V2109	12.5 1/2 - 10 3/8	021098
V2110	12.5 1/2 - 20 3/4	021104
V2111	20 3/4 - 12.5 1/2	021111

**Adjustable Wrench**  
• Offset jaw angle: 22.5°  
• DIN 3117 / ISO 6787

**Clé à molette**  
• Inclinaison de la tête : 22,5°  
• DIN 3117 / ISO 6787

**V1848, EAN 4047728018487**

Graduated millimeter scale  
Échelle à mm

max. 24 mm

**V1849, EAN 4047728018494**

max. 33 mm

Smooth jaw adjustment  
Réglage facile



**Double Open End Wrench Set**  
**V1461, EAN 4047728014618**  
• DIN 3113

**Jeu de clés à fourche**  
**V1461, EAN 4047728014618**  
• DIN 3113

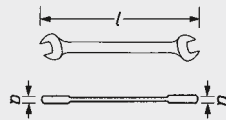

VIGOR No.	$\frac{1}{2}$ mm	L mm	$\frac{1}{2}$ mm	EAN 4047728+
V1471	6 x 7	105,0	3,4	014717
V1472	8 x 9	115,0	3,8	014724
V1473	10 x 11	130,0	4,4	014731
V1474	12 x 13	142,0	5,0	014748
V1475	14 x 15	152,0	5,6	014755
V1476	16 x 17	165,0	6,2	014762
V1669	16 x 18	205,0	6,2	016698
V1671	17 x 19	220,0	6,8	016711
V1477	18 x 19	175,0	6,8	014779
V1478	20 x 22	190,0	7,2	014786
V1479	21 x 23	205,0	7,8	014793
V1672	22 x 24	248,0	7,8	016728
V1480	24 x 27	215,0	8,4	014809
V1481	25 x 28	240,0	9,0	014816
V1482	30 x 32	260,0	9,6	014823

Not included in the set – Non livrée avec le jeu

**Combination Wrench Set**  
**V1054, EAN 4047728010542**  
• DIN 3113 / ISO 7738

**Jeu de clés mixtes**  
**V1054, EAN 4047728010542**  
• DIN 3113 / ISO 7738

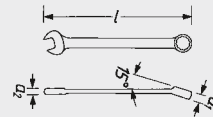

VIGOR No.	$\frac{1}{2}$ mm	L mm	a1 mm	a2 mm	EAN 4047728+
V1040	6	105,0	5,2	3,5	010405
V1041	7	115,0	6,2	3,8	010412
V1042	8	130,0	6,6	4,3	010429
V1043	9	142,0	7,0	4,3	010436
V1044	10	152,0	7,8	4,6	010443
V1045	11	165,0	8,1	4,8	010450
V1047	12	175,0	9,1	5,3	010474
V1048	13	190,0	9,6	5,6	010481
V1049	14	205,0	10,2	5,9	010498
V1050	15	215,0	10,9	6,3	010504
V1680	16	227,0	11,6	6,5	016803
V1051	17	240,0	11,7	6,9	010511
V1673	18	251,0	12,8	7,1	016735
V1052	19	260,0	12,3	8,0	010528
V1053	22	295,0	14,8	9,0	010535
V1674	24	330,0	15,8	9,6	016742
V1676	27	360,0	17,1	10,0	016766
V1677	30	390,0	18,5	11,0	016773
V1678	32	420,0	20,1	12,0	016780
V1679	36	450,0	21,5	13,0	016797

Not included in the set – Non livrée avec le jeu

# Wrenches Clés



**Double Box-End Wrench Set  
V1524, EAN 4047728015240**  
• DIN 838 / ISO 10104

**Jeu de clés polygonales  
V1524, EAN 4047728015240**  
• DIN 838 / ISO 10104

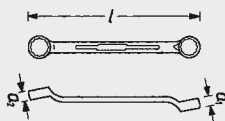

VIGOR No.	$\frac{1}{2}$ mm	L mm	$\frac{1}{2}$ a1 mm	$\frac{1}{2}$ a2 mm	EAN 4047728+
V1684	6 x 7	176,0	6,3	5,7	016841
V1685	8 x 9	190,5	7,7	6,7	016858
V1686	10 x 11	205,0	9,2	8,6	016865
V1687	12 x 13	220,5	9,9	9,5	016872
V1688	14 x 15	236,0	10,8	10,2	016889
V1689	16 x 17	250,0	12,0	11,4	016896
V1690	18 x 19	271,0	12,8	12,4	016902
V1691	20 x 22	291,0	14,0	13,2	016919
V1692	21 x 23	310,5	14,2	13,6	016926
V1693	24 x 27	331,0	15,6	14,4	016933
V1694	25 x 28	350,0	15,6	14,6	016940
V1695	30 x 32	371,0	16,9	16,4	016957

**Ratcheting Combination Wrench Set  
V1031, EAN 4047728010313**  
• 72 teeth = actuation angle 5°

**Jeu de clés mixtes à cliquet  
V1031, EAN 4047728010313**  
• 72 dents = angle de reprise de 5°

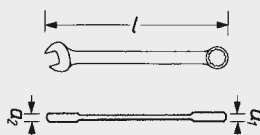

VIGOR No.	$\frac{1}{2}$ mm	L mm	$\frac{1}{2}$ a1 mm	$\frac{1}{2}$ a2 mm	EAN 4047728+
V1008	8	140,0	6,5	4,55	010085
V1009	9	151,0	6,9	5,15	010092
V1010	10	160,0	7,3	5,0	010108
V1021	11	165,0	7,7	5,6	010214
V1022	12	170,0	8,2	5,7	010221
V1023	13	177,0	8,7	6,5	010238
V1025	14	192,0	9,0	7,0	010252
V1026	15	200,0	9,5	7,1	010269
V1027	16	210,0	10,0	7,2	010276
V1028	17	225,0	10,4	7,8	010283
V1029	18	235,0	10,7	8,0	010290
V1030	19	245,0	11,3	9,0	010306

**STURDY  
STRONG  
GOOD**

**PUISSANT  
ROBUSTE  
QUALITATIF**



Double Ratcheting Box Wrench Set, 8-19 mm  
V1424,  
EAN 4047728014243

Jeu de clés polygonales à cliquet, 8-19 mm  
V1424,  
EAN 4047728014243

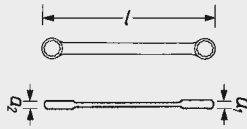

VIGOR No.	$\frac{1}{2}$ mm	mm	$\frac{1}{2}$ a1 mm	$\frac{1}{2}$ a2 mm	EAN 4047728+
V1430	8 x 9	235,0	7,4	7,4	014304
V1441	10 x 11	270,0	8,4	8,4	014410
V1442	12 x 13	300,0	8,4	8,4	014427
V1443	14 x 15	330,0	8,4	8,4	014434
V1444	16 x 18	375,0	10,0	11,5	014441
V1445	17 x 19	405,0	10,0	11,5	014458

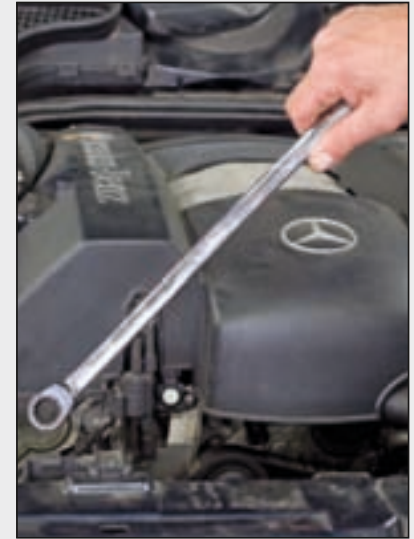

**Multifunction screw profiles (V1424/V1364)**  
**Profil de multifonction (V1424/V1364)**

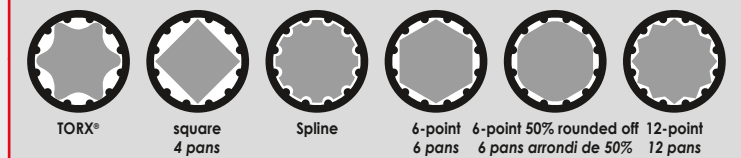

Ratcheting Aluminium Box Wrench Set, 10-19 mm  
V1364, EAN 4047728013642  
• Sizes 10; 13; 17; 19 mm

Jeu de clés polygonales à cliquet en aluminium, 10-19 mm  
V1364, EAN 4047728013642  
• Dimensions 10; 13; 17; 19 mm

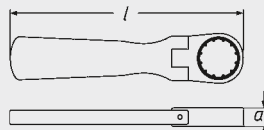

VIGOR No.	$\frac{1}{2}$ mm	mm	$\frac{1}{2}$ a1 mm	EAN 4047728+
V1400	8	89,8	7,4	014007
V1411	10	103,3	8,4	014113
V1412	12	116,2	8,4	014120
V1414	13	117,0	8,4	014144
V1415	14	129,7	8,4	014151
V1416	15	131,4	8,4	014168
V1417	16	142,5	8,4	014175
V1418	17	144,0	10,0	014182
V1419	18	156,2	11,4	014199
V1420	19	158,8	11,4	014205

Not included in the set - Non livrée avec le jeu



# Screwdriver / Bits Tournevis / Bits

EQUIPMENT  
**VIGOR**

## Screwdriver Set

V1637,  
EAN 4047728016377

• Fabricated according to DIN/ISO

## Jeu de tournevis

V1637,  
EAN 4047728016377

• Conformes à DIN / ISO



2K System

VIGOR No.	■	Contents Contenu	Sizes Dimensions mm	← L → mm	EAN 4047728+
V1698	⊖		3	75	016988
V1699	⊖		4	80	016995
V1700	⊖		5,5	125	017008
V1701	⊖		6,5	150	017015
V1702	⊕		PH 0	75	017022
V1703	⊕		PH 1	80	017039
V1704	⊕		PH 2	100	017046

## VDE Screwdriver Set

V2027, EAN 4047728020275

• Fabricated according to DIN/ISO

## Jeu de tournevis VDE

V2027, EAN 4047728020275

• Conformes à DIN / ISO

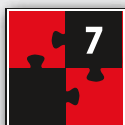

2K System

VIGOR No.	■	Contents Contenu	Sizes Dimensions mm	← L → mm	EAN 4047728+
V2028	⊖		3	75	020282
V2029	⊖		4	100	020299
V2030	⊖		5,5	125	020305
V2061	⊖		6,5	150	020619
V2062	⊕		PH 0	75	020626
V2063	⊕		PH 1	80	020633
V2064	⊕		PH 2	100	020640

NEW  
NOUVEAU  
NOUVEAU  
NEW



EQUIPMENT  
**VIGOR**

STURDY  
STRONG  
GOOD

PUISSANT  
ROBUSTE  
QUALITATIF

www.vigor-equipment.com



**Electronic Screwdriver Set  
in plastic case  
V1303, EAN 4047728013031**

- 1.6 x 50 mm; 2.0 x 50 mm;  
2.4 x 50 mm; 3.0 x 50 mm
- PH 00 x 50 mm; PH 0 x 50 mm

**Jeu de tournevis électroniques  
en boîte plastique  
V1303, EAN 4047728013031**

- 1,6 x 50 mm; 2,0 x 50 mm;  
2,4 x 50 mm; 3,0 x 50 mm
- PH 00 x 50 mm; PH 0 x 50 mm



**Voltmeter  
V1138, EAN 4047728011389**

- 150 up to 250 V, VDE-tested
- 220 up to 250 V according to VDE 0680
- 3 x 0.5 x 140 mm

**Tournevis détecteur de tension  
V1138, EAN 4047728011389**

- 150 V – 250 V, testé VDE
- 220–250 V conforme à VDE 0680
- 3 x 0,5 x 140 mm



**Screwdriver, short  
V1208,  
EAN 4047728012089**

- 5.5 x 38 mm

**Tournevis, court  
V1208,  
EAN 4047728012089**

- 5,5 x 38 mm



**Screwdriver, short  
V1209,  
EAN 4047728012096**

- PH 2 x 38 mm

**Tournevis, court  
V1209,  
EAN 4047728012096**

- PH 2 x 38 mm



**Bit-Box  
V1097,  
EAN 4047728010979**

- ~ DIN / ISO
- PH 1 (2x); PH 2 (2x); PH 3
- PZ 1 (2x); PZ 2 (2x); PZ 3
- 4 x 0.8 mm; 5 x 1.0 mm;  
6.5 x 1.2 mm; 8 x 1.6 mm
- 3; 4; 5; 6 mm
- TORX® T 15; T 20; T 25;  
T 27; T 30; T 40
- TORX® T 10H; T 15H; T 20H;  
T 25H; T 27H; T 30H

**Assortiment  
d'embouts-tournevis  
V1097,  
EAN 4047728010979**

- ~ DIN / ISO
- PH 1 (2x); PH 2 (2x); PH 3
- PZ 1 (2x); PZ 2 (2x); PZ 3
- 4 x 0,8 mm; 5 x 1,0 mm;  
6,5 x 1,2 mm; 8 x 1,6 mm
- 3; 4; 5; 6 mm
- TORX® T 15; T 20; T 25; T 27;  
T 30; T 40
- TORX® T 10H; T 15H; T 20H;  
T 25H; T 27H; T 30H



# Screwdriver / Bits Tournevis / Bits

EQUIPMENT  
**VIGOR**

## T-Handle Screwdriver Set 6-Point

V1409, EAN 4047728014090

- 2; 2.5; 3; 4; 5; 6; 8; 10 mm

## Jeu de tournevis avec manche en T 6 pans

V1409, EAN 4047728014090

- 2; 2.5; 3; 4; 5; 6; 8; 10 mm



## T-Handle Screwdriver Set TORX®

V1410, EAN 4047728014106

- T 9; T 10; T 15; T 20; T 25; T 27; T 30; T 40

## Jeu de tournevis avec manche en T TORX®

V1410, EAN 4047728014106

- T 9; T 10; T 15; T 20; T 25; T 27; T 30; T 40



## Offset Screwdriver Set in Clip

Jeu de clés mâles coudées en étui compact



TORX®

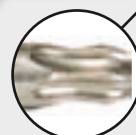

VIGOR No.	Composition	Surface	EAN
V1139	1,5 - 10 mm	burnished brunie	4047728+ 011396

VIGOR No.	Composition	Surface	EAN
V1181	T 9 - T 40	nickel plated nickelée	4047728+ 011815

Pliers Set  
V1615, EAN 4047728016155  
Jeu de pinces  
V1615, EAN 4047728016155

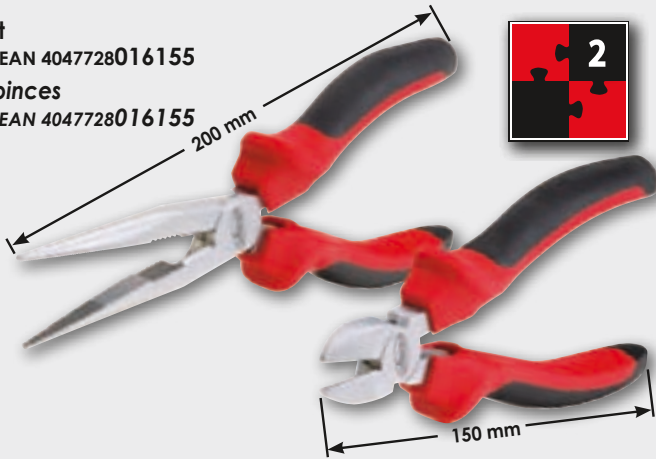

Combination Pliers  
V1616, EAN 4047728016162  
Pince universelle  
V1616, EAN 4047728016162



Water Pump Pliers  
V1426, EAN 4047728014267  
• DIN ISO 8976

Pince multiprise  
V1426, EAN 4047728014267  
• DIN ISO 8976



Diagonal Cutter  
V1617, EAN 4047728016179  
Pince coupante diagonale  
V1617, EAN 4047728016179



Lockring Pliers  
V1716, EAN 4047728017169  
Pince à circlips  
V1716, EAN 4047728017169



Lockring Pliers  
V1717, EAN 4047728017176  
Pince à circlips  
V1717, EAN 4047728017176



Lockring Pliers  
V1718, EAN 4047728017183  
Pince à circlips  
V1718, EAN 4047728017183



Lockring Pliers  
V1719, EAN 4047728017190  
Pince à circlips  
V1719, EAN 4047728017190





Grip Pliers Set, in tool roll  
V1808, EAN 4047728018081

Jeu de pinces-étau, en trousse souple  
V1808, EAN 4047728018081



VIGOR No.	Type Modèle	mm	EAN 4047728+
V1802		150	018029
V1803		250	018036
V1804		125	018043

Multi-Tool 14 in 1  
V1785, EAN 4047728017855

- Contents:
- 1 Combination pliers
- 1 Flat nose pliers
- 1 Wire cutter
- 1 Screwdriver 5.0 x 1.0 mm
- 1 Screwdriver 4.0 x 1.0 mm
- 1 Screwdriver 3.0 x 0.8 mm
- 1 Screwdriver PH 1
- 1 Single cut file
- 1 Cross cut file
- 1 Bottle opener
- 1 Can opener
- 1 Saw
- 1 Knife
- 1 Serrated knife

Outil-multifonction 14 en 1  
V1785, EAN 4047728017855

- Contenu:
- 1 Pince universelle
- 1 Pince plate
- 1 Cisailles à fil
- 1 Tournevis 5,0 x 1,0 mm
- 1 Tournevis 4,0 x 1,0 mm
- 1 Tournevis 3,0 x 0,8 mm
- 1 Tournevis PH 1
- 1 Lime à entaille
- 1 Lime à taille croisée
- 1 Ouvre-bouteille
- 1 Ouvre-boîtier
- 1 Scie
- 1 Couteau
- 1 Couteau scie

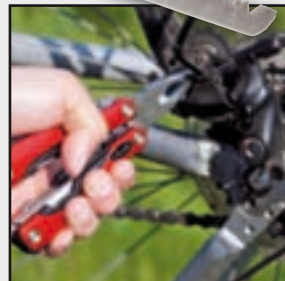

**Hammer**  
V1135, EAN 4047728011358

**Marteau**  
V1135, EAN 4047728011358



**Rubber Hammer**  
V1212, EAN 4047728012126

**Marteau en caoutchouc**  
V1212, EAN 4047728012126



**Center Punch**  
V1220, EAN 4047728012201

**Pointeau**  
V1220, EAN 4047728012201



**Drift Pins**  
Chasse-goupilles



**Flat Chisel**  
V1221, EAN 4047728012218

**Burin**  
V1221, EAN 4047728012218

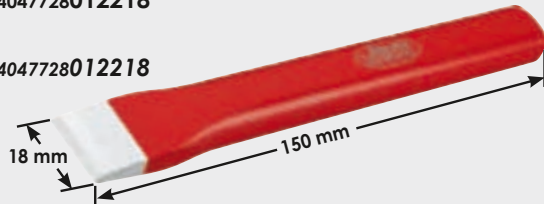

**Cape Chisel**  
V1222, EAN 4047728012225

**Bédane**  
V1222, EAN 4047728012225

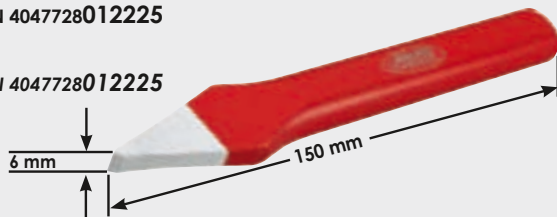

**Scraper**  
V1213, EAN 4047728012133

**Graffoir**  
V1213, EAN 4047728012133

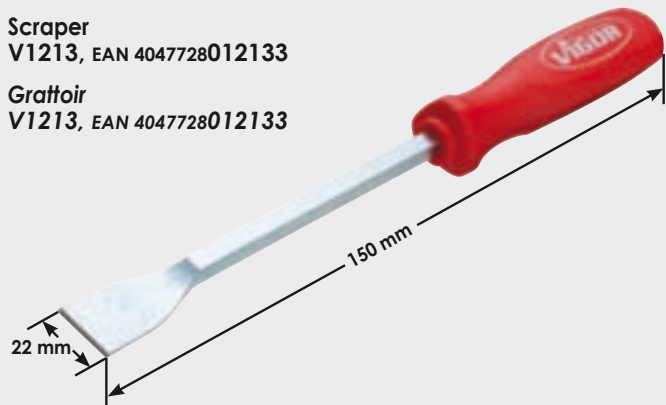

VIGOR No.	Contents Contenu	Width Largeur mm	L mm	EAN 4047728+
V1214		2	150	012140
V1215		3	150	012157
V1216		4	150	012164
V1217		5	150	012171
V1218		6	150	012188
V1219		8	150	012195

**Auto-Impact Center Punch**  
V1783, EAN 4047728017831

- Tough-hard punch tip
- The impact forces will be released by pressing down the upper part

**Pointeau automatique**  
V1783, EAN 4047728017831

- Pointe extrêmement dure
- Déclenchement de la force de percussion en appuyant sur la partie supérieure

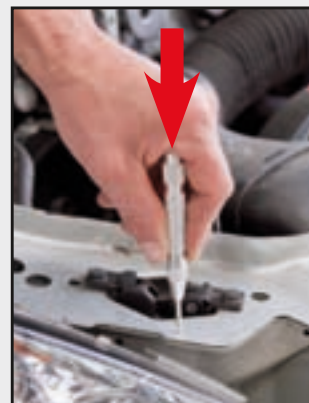

**Progressively adjustable**  
**Réglage progressif**

**Window Scraper**  
V1368, EAN 4047728013680

- Changeable blade
- To remove badges, stickers, vignettes etc.

**Graffoir pour pare-brise**  
V1368, EAN 4047728013680

- Lame interchangeable
- Pour décoller les vignettes, les autocollants, etc.



**Spare blades**  
V1372,  
EAN 4047728013727

**Lames de rechanges**  
V1372,  
EAN 4047728013727



**Scraper Set**  
V1283, EAN 4047728012836

- Dimensions:  
31 x 1,2 x 105/230 mm  
31 x 2,5 x 105/230 mm  
20 x 1,2 x 55/175 mm  
20 x 2,5 x 55/175 mm

**Jeu de grattoirs**  
V1283, EAN 4047728012836

- Dimensions :  
31 x 1,2 x 105/230 mm  
31 x 2,5 x 105/230 mm  
20 x 1,2 x 55/175 mm  
20 x 2,5 x 55/175 mm



With impact cap  
Avec percuteur



**Lever Removing Set**  
V1369, EAN 4047728013697

- To remove the interior carpeting, protection caps, cover caps etc.

**Jeu de leviers de démontage**  
V1369, EAN 4047728013697

- Pour démonter les garnitures de porte, les capuchons de protection et de fermeture etc.



**Hook and Scraper Set**  
V1723, EAN 4047728017237

**Jeu de grattoirs et crochets**  
V1723, EAN 4047728017237

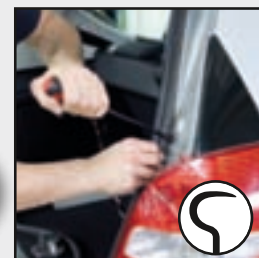

**Pry Bar Set**  
**V1301, EAN 4047728013017**

- Shock-resistant handle

**Jeu de leviers d'effort**  
**V1301, EAN 4047728013017**

- Manche résistant aux chocs

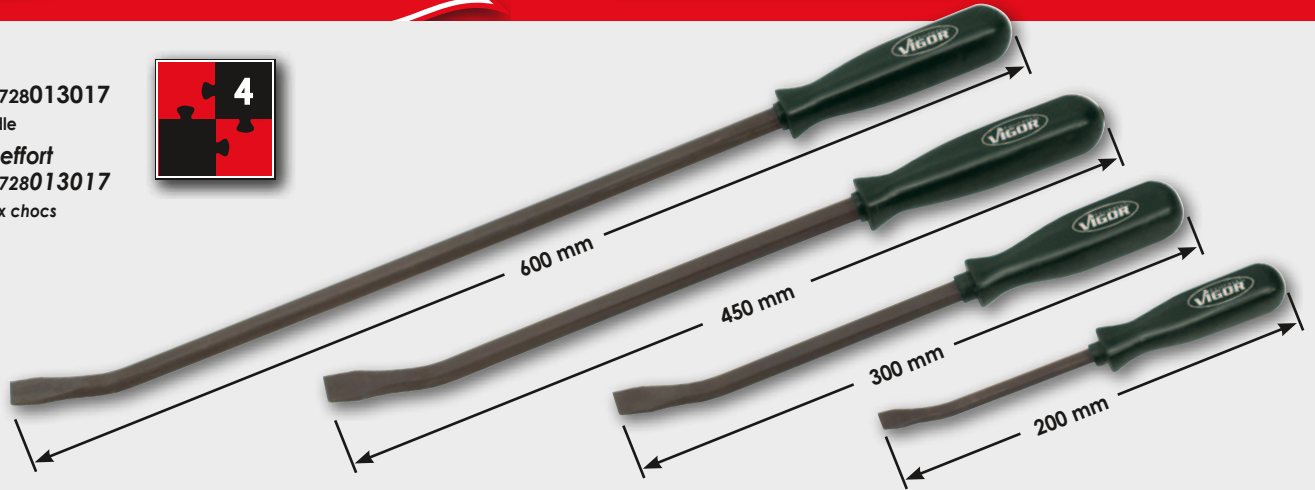

**Wrenching Bar 70 cm**  
**V1429, EAN 4047728014298**

**Pied-de-biche 70 cm**  
**V1429, EAN 4047728014298**



**Indexable Ratcheting Pry Bar Set**  
**V1437, EAN 4047728014373**

- Indexable Ratcheting Pry Bar allows easy access into areas which are difficult to reach
- Auto forward locking ratchet design mechanism



**Jeu de pieds-de-biche ajustables**  
**V1437, EAN 4047728014373**

- Pied-de-biche ajustable pour l'utilisation aux endroits difficiles à atteindre
- Verrouillage automatique grâce au mécanisme de cliquet

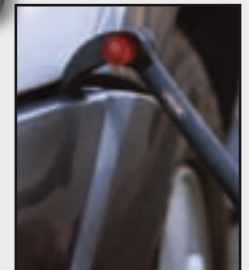
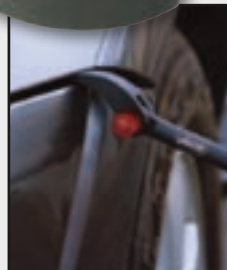
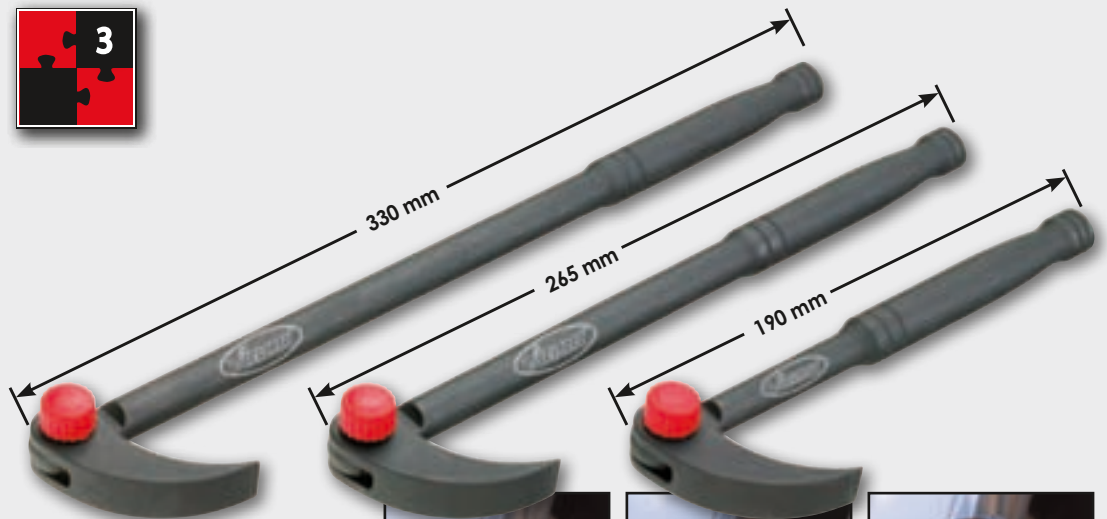



6.3 1/4"

## Brush Assortment <sup>CS</sup> V1921, EAN 4047728019217

- For professional cleaning and deburring of cylinders, tubes, bushings, etc.
- Suitable for drilling machines and pneumatic drills
- Contents:
  - 12 nylon brushes: Ø 8; 9; 10; 11; 12; 13; 14; 15; 16; 17; 18; 19 mm
  - 12 steel brushes: Ø 8; 9; 10; 11; 12; 13; 14; 15; 16; 17; 18; 19 mm
  - 12 brushes with brass coating: Ø 8; 9; 10; 11; 12; 13; 14; 15; 16; 17; 18; 19 mm
  - 1 handle with <sup>CS</sup> adapter and quick lock
  - 1 extension: 150 mm

## Assortiment de brosses écouvillons <sup>CS</sup> V1921, EAN 4047728019217

- Permet le nettoyage et l'ébavurage professionnels des cylindres, tubes, douilles etc.
- Approprié à l'utilisation avec des perceuses standards et à air comprimé
- Contenu:
  - 12 brosses écouvillons en nylon: Ø 8; 9; 10; 11; 12; 13; 14; 15; 16; 17; 18; 19 mm
  - 12 brosses écouvillons en acier: Ø 8; 9; 10; 11; 12; 13; 14; 15; 16; 17; 18; 19 mm
  - 12 brosses écouvillons laitonées: Ø 8; 9; 10; 11; 12; 13; 14; 15; 16; 17; 18; 19 mm
  - 1 manche avec raccord <sup>CS</sup> et verrouillage rapide
  - 1 rallonge: 150 mm



**Note:**  
When operating with power tools only use the brushes rotating to the right!  
Lors de l'utilisation avec machine, il est important de choisir la rotation à droite !

Application note as pdf-file on "www.vigor-equipment.com"

Fichier pdf de la notice d'utilisation téléchargeable sur « www.vigor-equipment.com »

Brushes with brass coating  
Brosses écouvillons laitonées



Set with 10 pieces  
Jeu de 10 pièces

Steel brushes  
Brosses écouvillons en acier



Set with 10 pieces  
Jeu de 10 pièces

Nylon brushes  
Brosses écouvillons en nylon



Set with 10 pieces  
Jeu de 10 pièces

VIGOR No.	■	■	Ø mm	EAN 4047728+
V1924	6.3 1/4	10	8	019248
V1925	6.3 1/4	10	9	019255
V1926	6.3 1/4	10	10	019262
V1927	6.3 1/4	10	11	019279
V1928	6.3 1/4	10	12	019286
V1929	6.3 1/4	10	13	019293
V1930	6.3 1/4	10	14	019309
V1931	6.3 1/4	10	15	019316
V1932	6.3 1/4	10	16	019323
V1933	6.3 1/4	10	17	019330
V1934	6.3 1/4	10	18	019347
V1935	6.3 1/4	10	19	019354

VIGOR No.	■	■	Ø mm	EAN 4047728+
V1936	6.3 1/4	10	8	019361
V1937	6.3 1/4	10	9	019378
V1938	6.3 1/4	10	10	019385
V1939	6.3 1/4	10	11	019392
V1940	6.3 1/4	10	12	019408
V1941	6.3 1/4	10	13	019415
V1942	6.3 1/4	10	14	019422
V1943	6.3 1/4	10	15	019439
V1944	6.3 1/4	10	16	019446
V1945	6.3 1/4	10	17	019453
V1946	6.3 1/4	10	18	019460
V1947	6.3 1/4	10	19	019477

VIGOR No.	■	■	Ø mm	EAN 4047728+
V1948	6.3 1/4	10	8	019484
V1949	6.3 1/4	10	9	019491
V1950	6.3 1/4	10	10	019507
V1951	6.3 1/4	10	11	019514
V1952	6.3 1/4	10	12	019521
V1953	6.3 1/4	10	13	019538
V1954	6.3 1/4	10	14	019545
V1955	6.3 1/4	10	15	019552
V1956	6.3 1/4	10	16	019569
V1957	6.3 1/4	10	17	019576
V1958	6.3 1/4	10	18	019583
V1959	6.3 1/4	10	19	019590

## 360° Chain Brush for Motorcycle, Bicycle and Drive Chain Cleaning V1915, EAN 4047728019156

- For the 360° cleaning of 400, 500 and 600 series drive chains on ATV (Quads), motorcycles and for industrial applications
- Gentle cleaning of chains with O, X and Z rings

## 360° Brosse à chaîne pour nettoyer les chaînes des motos / bicyclettes / d'entraînement V1915, EAN 4047728019156

- Pour le nettoyage de 360° des chaînes de motocyclettes, de VTT et industrielles des séries 400, 500 et 600
- Nettoyage des chaînes à joints toriques classiques (O-ring), des chaînes de basse friction (X-ring et Z-ring)

360° cleaning ~1000 bristles  
nettoyage de 360° ~1000 poils

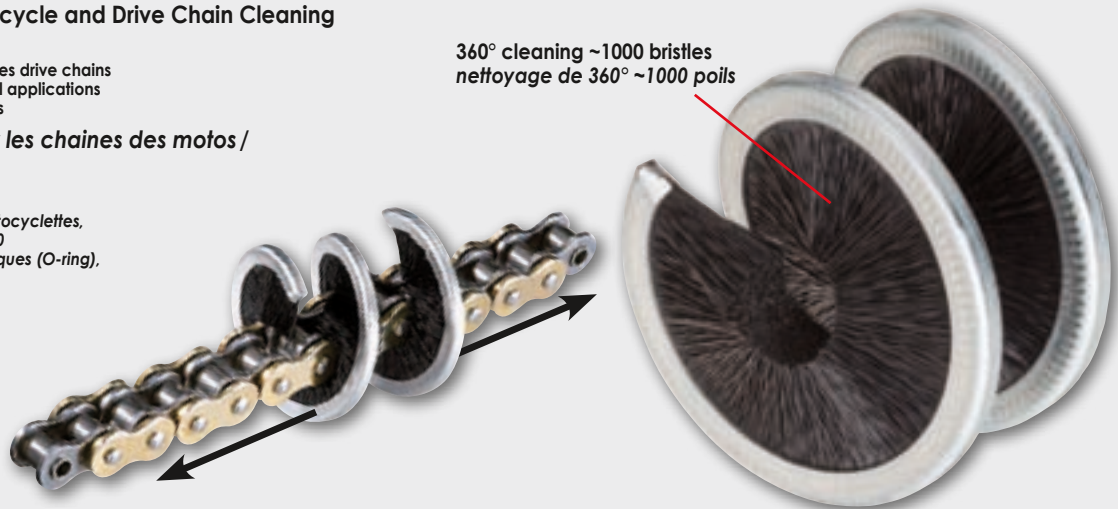

**Tweezers Set**  
V1438, EAN 4047728014380



**Jeu de pincettes**  
V1438, EAN 4047728014380

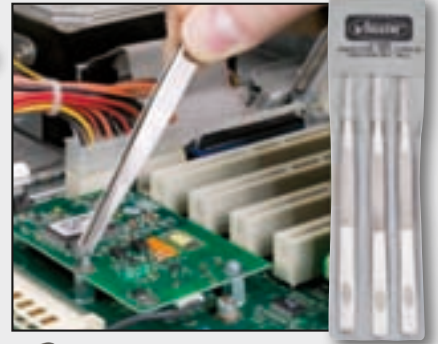

**Tweezers with LED Light**  
V1780, EAN 4047728017800

**Pincette avec LED**  
V1780, EAN 4047728017800

• 3x LR41 1,5 V - 210 mAh

• 3x LR41 1,5 V - 210 mAh

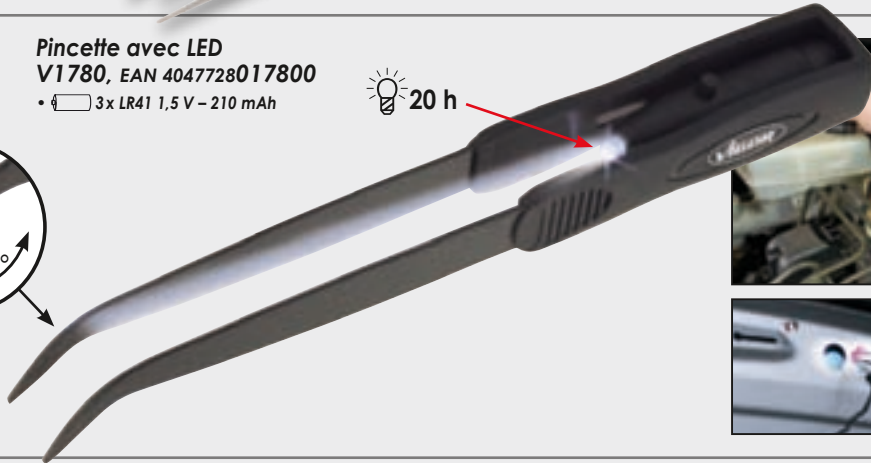
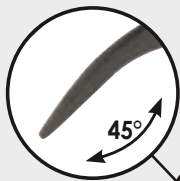

**Magnetic Pick-up Tool**  
V1741, EAN 4047728017411

**Aimant télescopique**  
V1741, EAN 4047728017411



133 - 645 mm



**Flexible Pick-Up Tool**  
V1764, EAN 4047728017640

700 mm

**Doigt flexible**  
V1764, EAN 4047728017640

700 mm



**Precision Oiler**  
V1893, EAN 4047728018937

• Application range:  
passenger cars, bicycles, locks, model making, sewing machines, hinges, power tools, lubricating / spraying and lots more

**Burette-stylo d'huile**  
V1893, EAN 4047728018937

• Domaines d'application :  
automobiles, deux-roues, serrures, modélisme, machines à coudre, charnières, outils électriques, lubrifier / vaporiser etc.

With screw cap  
Capuchon de protection  
vissable

Aluminium housing  
Boîtier en aluminium

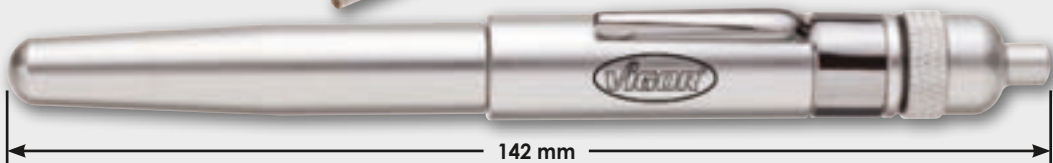

**Universal Puller Set**

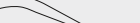

V1810, EAN 4047728018104

- To be used as internal puller 
- jaw capacity 50-170 mm
- and external puller 
- jaw capacity 10-180 mm
- Self-gripping and self-centring
- Puller hooks can be added or removed by inverting the hooks
- Locking of the puller hooks by knurled screw



- Contents:
- 1x 
  - 3x  50 - 170 mm
  - 3x  10 - 180 mm

**Jeu d'extracteurs universels**  
V1810, EAN 4047728018104

- Possibilité d'utilisation en tant qu'extracteur intérieur 
- capacité de serrage 50-170 mm et extérieur
- capacité de serrage  10-180 mm
- Auto-serrant et auto-centrant
- Possibilité d'ajouter et d'ôter les crochets grâce aux crochets réversibles
- Verrouillage des crochets par vis moletée

- Contenu:
- 1x 
  - 3x  50 - 170 mm
  - 3x  10 - 180 mm

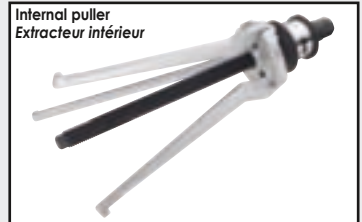
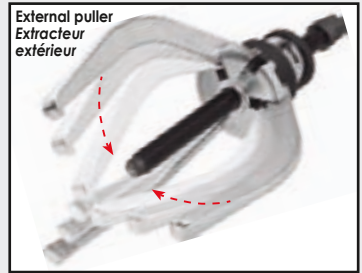

**Cordless Mini Grinder**

V1720, EAN 4047728017206

- For precise drilling, polishing, grinding etc.
- 7.2 V - 1000 mA

**Ponceuse sans fil**

V1720, EAN 4047728017206

- Pour le fraisage, polissage, meulage etc.
- 7.2 V - 1000 mA

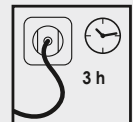

Comprehensive operating instructions as pdf-file on "www.vigor-equipment.com"

Fichier pdf du mode d'emploi téléchargeable sur « www.vigor-equipment.com »



Kneeling Mat  
V2338, EAN 4047728023382

Protège-genoux  
V2338, EAN 4047728023382



Soldering Iron  
V1367, EAN 4047728013673  
• 3x AA 1,5 V

Fer à souder  
V1367, EAN 4047728013673  
• 3x AA 1,5 V





# Measuring Tools Outillage de mesure

EQUIPMENT  
**VIGOR**

Digital Calliper  
V1713, EAN 4047728017138

• 1.5 V (LR44) - 180 mAh

Pied à coulisse digital  
V1713, EAN 4047728017138

• 1.5 V (LR44) - 180 mAh

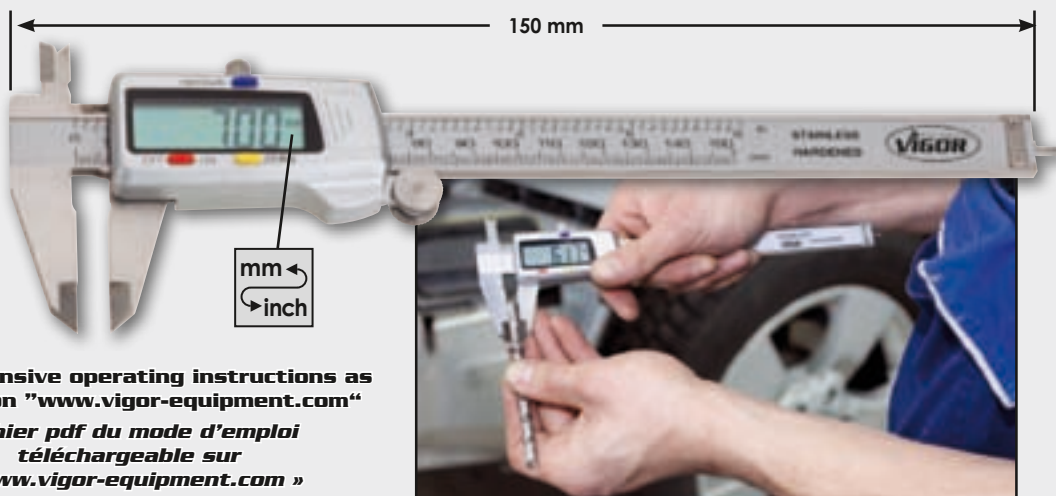

Comprehensive operating instructions as pdf-file on "www.vigor-equipment.com"

Fichier pdf du mode d'emploi téléchargeable sur « www.vigor-equipment.com »

Tape Measure  
V1724, EAN 4047728017244

Mètre-ruban  
V1724, EAN 4047728017244



Feeler Gauge  
V1714, EAN 4047728017145

Jauge d'épaisseur  
V1714, EAN 4047728017145



**STURDY ■ STRONG ■ GOOD  
PUISSANT ■ ROBUSTE ■ QUALITATIF**

EQUIPMENT  
**VIGOR**



www.vigor-equipment.com

# Cutting and Sawing Coupage, sciage, décolletage

Saw Frame  
V1715, EAN 4047728017152

Monture de scie  
V1715, EAN 4047728017152

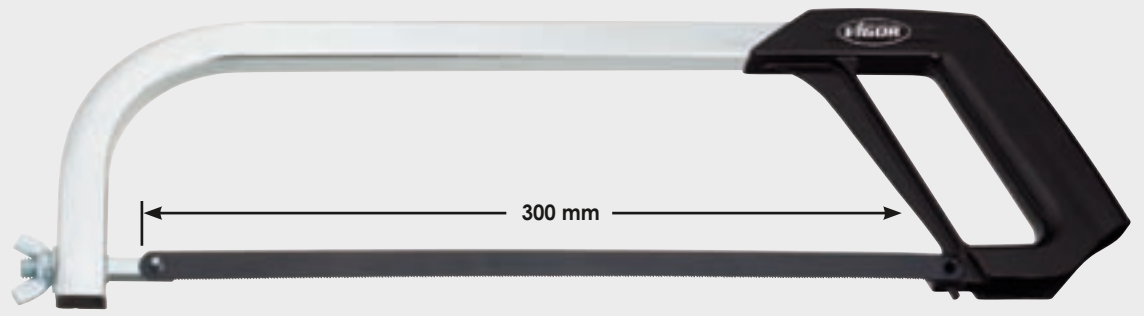

Multi-Tool Saw / Screwdriver  
V1822, EAN 4047728018227

Porte-outils pour scie et embouts  
V1822, EAN 4047728018227

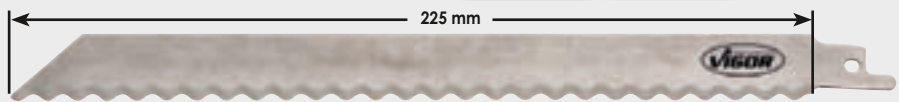

for insulation material, rubber, foam, cardboard and polystyrene – with serrated edge  
pour couper le matériel isolant, le caoutchouc, la mousse, le carton et le polystyrène – tranchant ondulé



for wood and plastic material – 10 teeth / inch  
pour couper le bois et le plastique – 10 dents / pouce

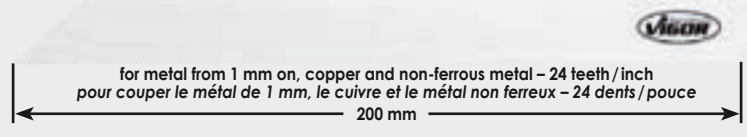

for metal from 1 mm on, copper and non-ferrous metal – 24 teeth / inch  
pour couper le métal de 1 mm, le cuivre et le métal non ferreux – 24 dents / pouce

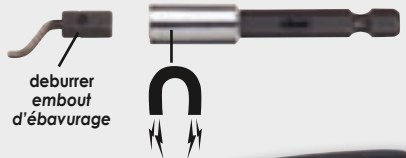

"Made in Germany"



**Cutting and Sawing**  
*Coupage, sciage, décolletage*

EQUIPMENT  
**VIGOR**

Japanese Pull-Stroke Saw  
 V1809, EAN 4047728018098

Scie japonaise  
 V1809, EAN 4047728018098

**"Made in Japan"**  
**« Fabriqué au Japon »**



Universal Shears  
 V1304, EAN 4047728013048

Ciseau universel  
 V1304, EAN 4047728013048



Universal Knife  
 V1345, EAN 4047728013451

Couteau universel  
 V1345, EAN 4047728013451

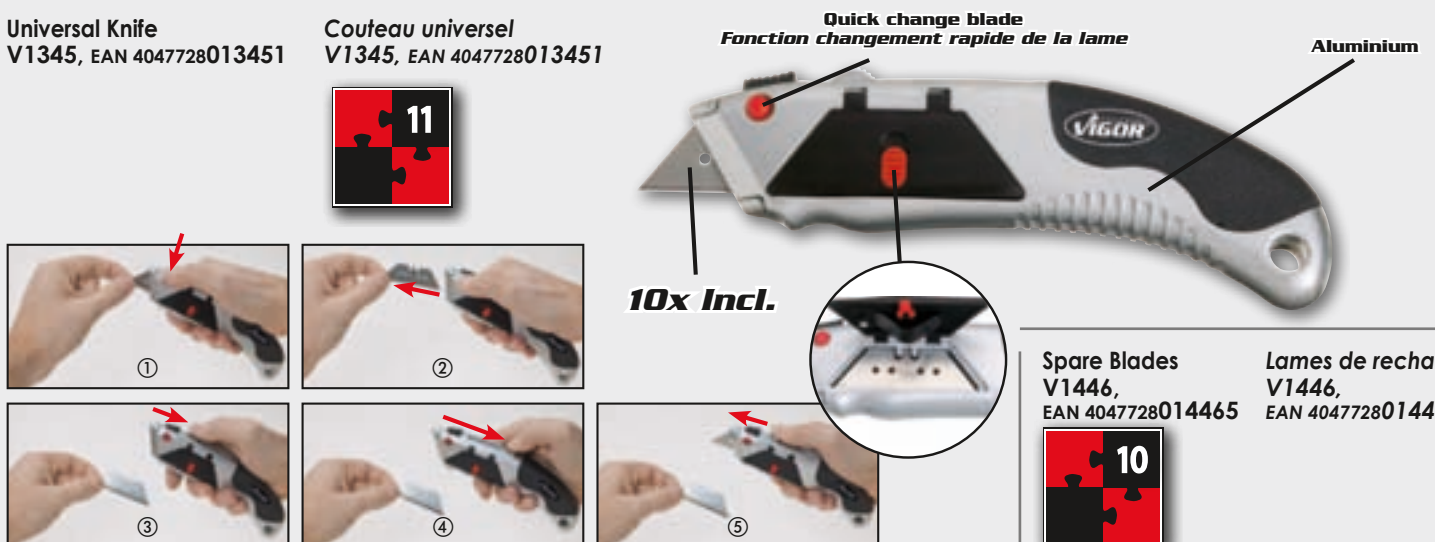

Spare Blades  
 V1446,  
 EAN 4047728014465

Lames de rechange  
 V1446,  
 EAN 4047728014465

Hole Saw Set  
V1767, EAN 4047728017671



Jeu de scies cloches  
V1767, EAN 4047728017671

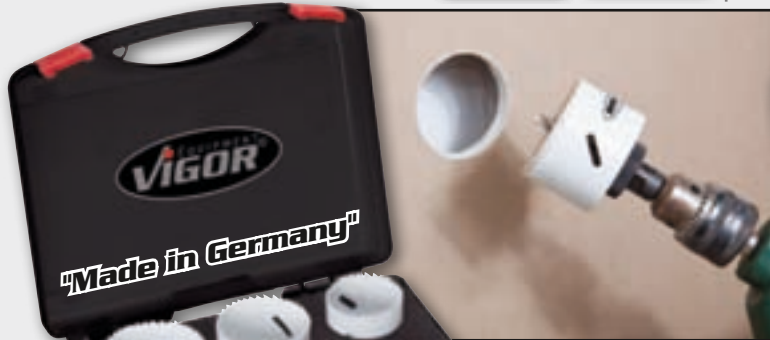

Hole Saw Set  
V1768, EAN 4047728017688



Jeu de scies cloches  
V1768, EAN 4047728017688

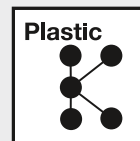
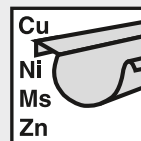
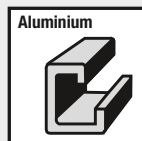
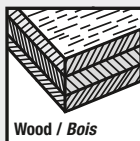
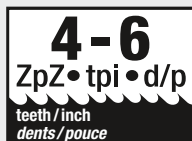
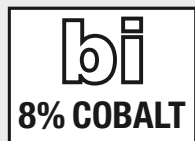

**STURDY ■ STRONG ■ GOOD**  
**PUISSANT ■ ROBUSTE ■ QUALITATIF**



# Cutting and Sawing Coupage, sciage, décolletage

EQUIPMENT  
**VIGOR**

Hose Cutter  
V1891, EAN 4047728018913

Coupe-tubes  
V1891, EAN 4047728018913

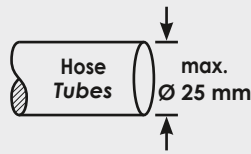

Spare Blades for Hose Cutter V1891  
V1920, EAN 4047728019200

Lames de rechange pour coupe-tubes V1891  
V1920, EAN 4047728019200

## Files

- Teeth (cut): 2 = medium
- DIN 7261

## Limes d'atelier

- Dentition (taille): 2 = moyenne
- DIN 7261

Flat Hand File  
V1787, EAN 4047728017879

Lime d'atelier plate  
V1787, EAN 4047728017879

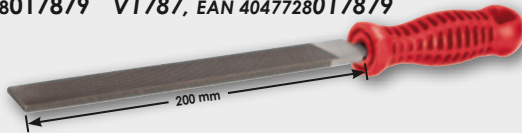

Three Square File  
V1788, EAN 4047728017886

Lime d'atelier triangulaire  
V1788, EAN 4047728017886



Square File  
V1789, EAN 4047728017893

Lime d'atelier carrée  
V1789, EAN 4047728017893



Half Round File  
V1790, EAN 4047728017909

Lime d'atelier demi-ronde  
V1790, EAN 4047728017909



Round File  
V1801, EAN 4047728018012

Lime d'atelier ronde  
V1801, EAN 4047728018012

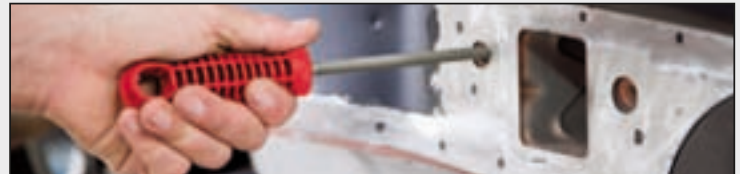

Twist Drill Set  
V1203, EAN 4047728012034

Jeu de forets hélicoïdaux  
V1203, EAN 4047728012034

- DIN 338 – for metal
- 19 Twist drills 1–10 mm rising by 0.5 mm

Jeu de forets HSS  
V1707, EAN 4047728017077

Jeu de forets étagés HSS  
V1707, EAN 4047728017077

- 3 HSS step drills 16, 18, 20 mm

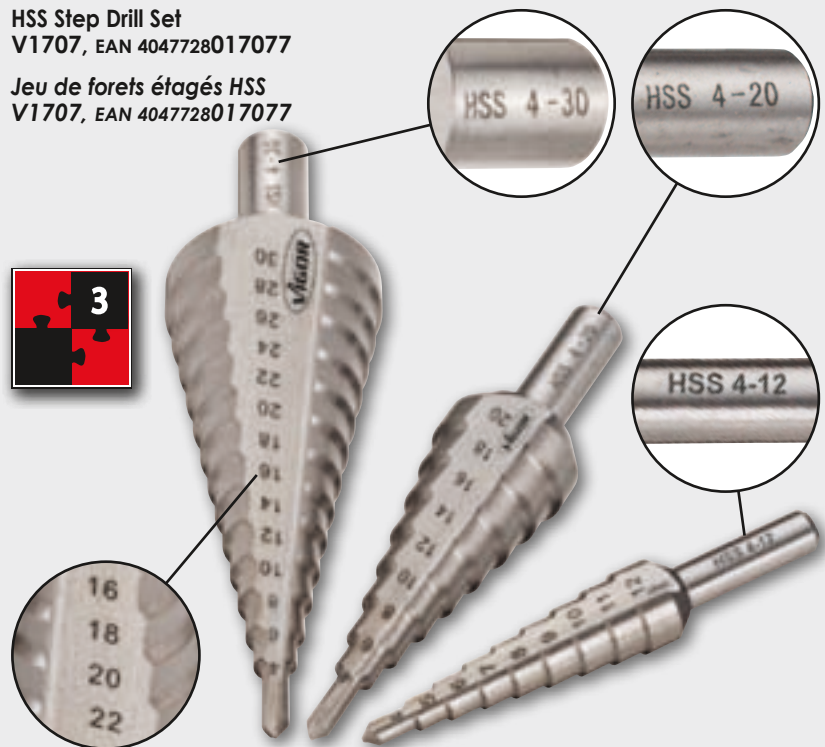

Available from August 2011

*Livrable à partir du  
mois d'août 2011*



**Tap Set**

**V2253, EAN 4047728022538**

- DIN/EN 22568
- HSS material, ground
- Contents:  
7 Hand Tap Sets (consisting of Taper Tap, Regroover and Second Tap)
- 7 Round Dies M3; M4; M5; M6; M8; M10; M12
- 1 Tap Wrench
- 1 Die Stock
- 1 Thread Gauge
- 1 Screwdriver



**Jeu de tarauds**

**V2253, EAN 4047728022538**

- DIN/EN 22568
- Matière HSS, rectifiée
- Contenu:  
7 jeux de tarauds à main (comprenant: taraud ébaucheur, taraud intermédiaire et taraud finisseur)
- 7 filières rondes M3; M4; M5; M6; M8; M10; M12
- 1 tourne-à-gauche
- 1 support pour filières
- 1 calibre de filetage
- 1 tournevis



**Twist Drill Set**

**V1408, EAN 4047728014083**

- DIN 338 for metal
- Twist drills 1 to 10 mm rising by 0.5 mm
- 10 pcs. each drill size 1 mm to 8 mm
- 5 pcs. each drill size 8.5 mm to 10 mm

**Jeu de forets hélicoïdaux**

**V1408, EAN 4047728014083**

- DIN 338 pour métal
- Forets hélicoïdaux 1 jusque 10 mm, augmentation de 0,5 mm
- De 1 mm – 8,0 mm, 10 pièces de chaque taille;
- de 8,5 – 10 mm, 5 pièces de chaque taille;

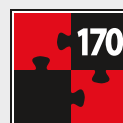

**LED Light  
V1463, EAN 4047728014632**

• Rechargeable NiMH battery 3 h

**Lampe à LED  
V1463, EAN 4047728014632**

• Batterie rechargeable NiMH 3 h



**Comprehensive operating instructions as pdf-file on "www.vigor-equipment.com"**  
**Fichier pdf du mode d'emploi téléchargeable sur « www.vigor-equipment.com »**

**LED Multifunction Light  
V1779, EAN 4047728017794**

• 2 x CR2032 3 V - 210 mAh  
 12 h

**Lampe multifonction LED  
V1779, EAN 4047728017794**

• 2 x CR2032 3 V - 210 mAh  
 12 h



**LED Folding Light  
V2316, EAN 4047728023160**

• Lithium-Ion battery; 3.6 V 3,5 - 4 h  
5 LED = 300 at a distance 60 cm  
18 LED = 800 at a distance 60 cm  
 approx. 200 g

**Lampe pliante à LED  
V2316, EAN 4047728023160**

• Li-Ion batterie; 3.6 V 3,5 - 4 h  
• 5 LEDs = 300 à une distance de 60 cm  
• 18 LEDs = 800 à une distance de 60 cm  
• env. 200 g



**Comprehensive operating instructions as pdf-file on "www.vigor-equipment.com"**  
**Fichier pdf du mode d'emploi téléchargeable sur « www.vigor-equipment.com »**



**12V Charging Cable  
for LED Folding Light V2316  
V2347, EAN 4047728023474**

• For cigarette lighter

**12V Câble de chargement  
pour lampe pliante à LED V2316  
V2347, EAN 4047728023474**

• Pour allume-cigare



**Mini LED Flash Light**  
V1914, EAN 4047728019149

- Pocket clip
- 6 bright LED
- Incl. 3 x AAA
- appr. 24 h



With  
Pocket clip  
Avec agrafe

**Mini-Baladeuse LED**  
V1914, EAN 4047728019149

- Avec agrafe
- 6 LED très claires
- Incl. 3 x AAA
- env. 24 h

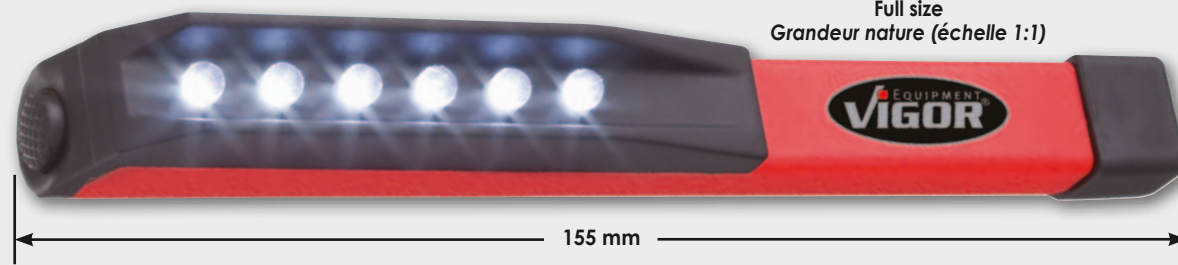

Full size  
Grandeur nature (échelle 1:1)

**UV Torch 9 LED and 3 UV-LED**  
V1912, EAN 4047728019125

- 9 white LED and 3 UV-LED
- Incl. 3 x AAA
- 9 LED ~ appr. 8 h / 3 UV-LED ~ appr. 18 h

**Lampe torche en métal, avec 9 LED et 3 LED UV**  
V1912, EAN 4047728019125

- 9 LED blanches et 3 LED UV
- Incl. 3 x AAA
- 9 LED ~ env. 8 h / 3 UV-LED ~ env. 18 h

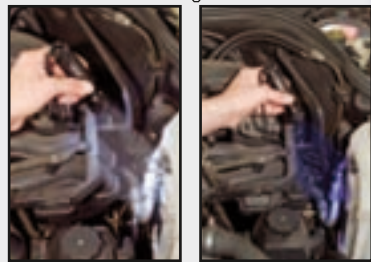

50 cm  
9 LED =  
approx./env.  
1300-1400 Lux



50 cm  
3 UV-LED =  
approx./env.30 Lux



- = white/blanc
- = off / éteint
- = blue / bleu
- = off / éteint

**Headlamp with 3 Watt Cree LED**  
V1911, EAN 4047728019118

- Luminous power: 100 LUMEN
- Incl. 3 x AAA
- appr. 3 h
- 80 g

**Lampe frontale avec LED Cree de 3 watts**  
V1911, EAN 4047728019118

- Intensité lumineuse : 100 lumens
- Incl. 3 x AAA
- env. 3 h
- 80 g

- = standard light on / économie
- = bright light on / pleine puissance
- = light flashing / clignotant

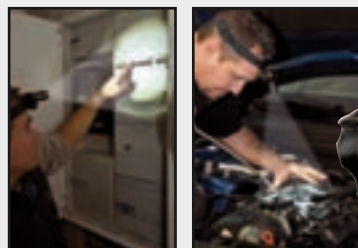

Adjustable headlight inclination (5 positions)  
Tête orientable en 5 positions



**Fixed Torque Wrench**  
V1333, EAN 4047728013338  
• Release accuracy  $\pm 4\%$

**Clé dynamométrique pré-réglée**  
V1333, EAN 4047728013338  
• Précision de déclenchement  $\pm 4\%$

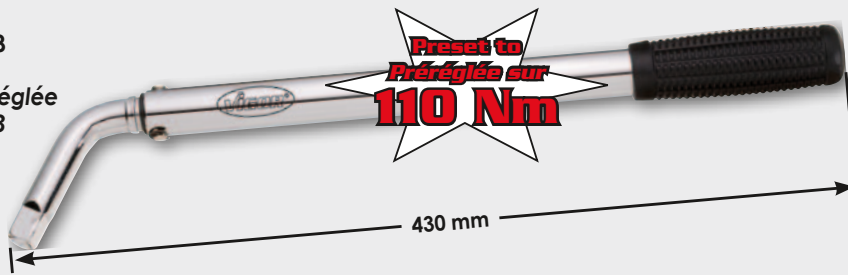

**Torque Control Impact Socket Set**  
V1761, EAN 4047728017619  
**Jeu de douilles à chocs à couple limité**  
V1761, EAN 4047728017619



**Torque Control Impact Socket Set, extra-long**  
V1762, EAN 4047728017626  
**Jeu de douilles à chocs, extra-longues, à couple limité**  
V1762, EAN 4047728017626



**Note: / Note :**



Only suitable for pre-tightening. Retightening with a torque wrench, e.g. VIGOR V1333 is absolutely necessary!  
Approprié au préserrage uniquement. Revissage avec une clé dynamométrique, par. ex. VIGOR V1333, indispensable !

## Torque Adapter

- High measuring accuracy, documented by a certificate according to DIN EN ISO 6789
- Controlled screw tightening to right and left (to be used with a ratchet)
- Display modes: Tracking mode and peak mode (peak value indication)
- Storage of 50 torque value readings
- With serial number and certificate
- LCD display and unit selections Nm, lbf-ft, lb-in, kg-m and kg-cm
- Automatic shut-off
- Approaching of the target value is indicated by an intermittent buzzer
- $\square$  3.0 V (CR2032) – 240 mAh



## Adaptateur dynamométrique

- Haute précision de mesure, consignée dans le certificat selon DIN EN ISO 6789
- Pour le serrage contrôlé à droite et à gauche (utiliser avec un cliquet)
- Modes d'utilisation: Track (affichage des valeurs) et Peak (indication de la valeur de pic)
- Mémorisation de 50 valeurs
- Avec numéro de série et certificat
- Écran LCD avec affichage des valeurs en Nm, lbf-ft, lb-in, kg-m et kg-cm
- Avec arrêt automatique
- Son intermittent (buzzer) retentit quand la valeur pré-réglée est atteinte
- $\square$  3.0 V (CR2032) – 240 mAh

Comprehensive operating instructions as pdf-file on "www.vigor-equipment.com"  
Fichier pdf du mode d'emploi téléchargeable sur « www.vigor-equipment.com »



VIGOR No.	■	Release accuracy Précision de déclenchement	Nm	Lbf·ft	— L x W — — L x l — mm	EAN 4047728+
V1760	6.3 ¼	$\pm 4\%$	6 – 30	4 – 16	75 x 45	017602
V1759	10 ¾	$\pm 3\%$	27 – 135	20 – 99	75 x 45	017596
V1758	12 ½	$\pm 2\%$	40 – 200	30 – 147	75 x 45	017589

**Video Endoscope**

4 x LR 6, Size AA, 1.5 V



**Vidéo endoscope**

4 x LR 6, dimension AA, 1,5 V



Comprehensive operating instructions as pdf-file on "www.vigor-equipment.com"  
Fichier pdf du mode d'emploi téléchargeable sur "www.vigor-equipment.com"

**Accessories only for V1771  
Accessoires pour V1771 uniquement**



VIGOR No.	Ø mm	mm	Probe Sonde	Camera Caméra	EAN 4047728+
V1771	10,0	1000	semi-rigid / semi-rigide	0°	017718
V1772	5,8	1000	semi-rigid / semi-rigide	0°	017725
V1773	5,5	1000	flexible / flexible	90°	017732

**Spare Camera Cable**

**Câble de rechange pour caméra**

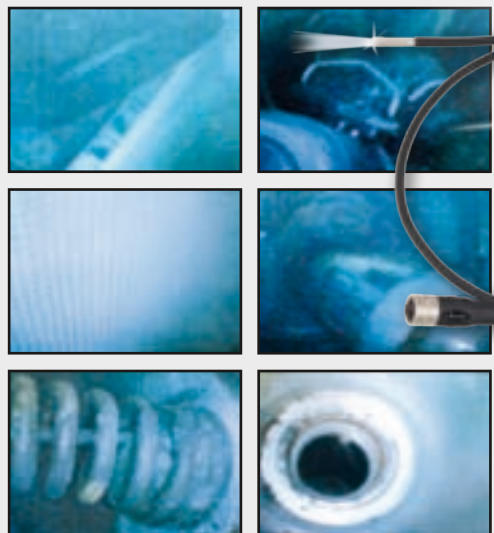

VIGOR No.	Ø mm	mm	Probe Sonde	Camera Caméra	EAN 4047728+
V1774	10,0	3000	semi-rigid / semi-rigide	0°	017749
V1775	5,8	1000	semi-rigid / semi-rigide	0°	017756
V1777	5,8	2000	semi-rigid / semi-rigide	0°	017770
V1776	5,5	1000	flexible / flexible	90°	017763
V1778	5,5	2000	flexible / flexible	90°	017787

**Battery and Charging System Tester with Thermal Printer**  
**V1922, EAN 4047728019224**

- Used for testing of built-in batteries
- With starter system and charging system test
- LCD display: voltage, battery capacity and battery capacity available in temperature measurements
- Operating range:  
40 – 2000 A SAE  
40 – 2100 A EN2  
50 – 2500 A EN1  
25 – 1300 A DIN  
30 – 1500 A IEC

**Testeur de batterie et de circuit de charge avec imprimante thermique**  
**V1922, EAN 4047728019224**

- Permet de tester la batterie montée
- Avec test du système de démarrage et du circuit de charge
- Affichage LCD : tension, état de la batterie et la capacité disponible de la batterie évolue en fonction de la température
- Champs d'activité :  
40 – 2000 A SAE  
40 – 2100 A EN2  
50 – 2500 A EN1  
25 – 1300 A DIN  
30 – 1500 A IEC

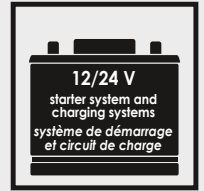
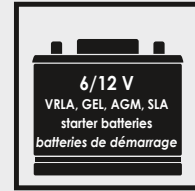
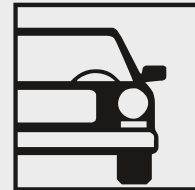

**Spare Thermal Paper Rolls**  
**V1923, EAN 4047728019231**

**Rouleaux de papier thermique de rechange**  
**V1923, EAN 4047728019231**



**Battery Tester**  
**V1757, EAN 4047728017572**

- For testing the battery voltage, the generator and starter motor

**Testeur de batterie**  
**V1757, EAN 4047728017572**

- Pour contrôler la tension de la batterie, l'alternateur et le démarreur

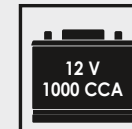
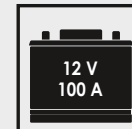
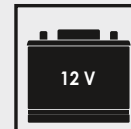
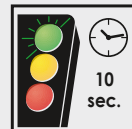

**Comprehensive operating instructions as pdf-file on "www.vigor-equipment.com"**  
**Fichier pdf du mode d'emploi téléchargeable sur « www.vigor-equipment.com »**

Battery Carrier  
V1435, EAN 4047728014359

Porte-batterie  
V1435, EAN 4047728014359

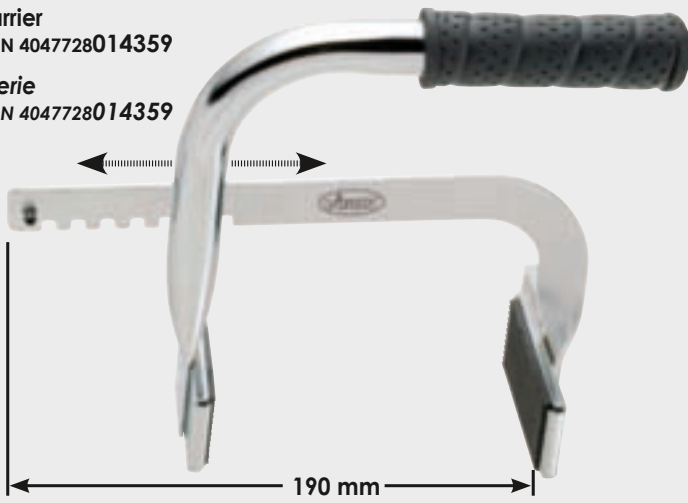

Car Light Tester  
V1722, EAN 4047728017220

⚡ 6-24 V

Testeur d'éclairage auto  
V1722, EAN 4047728017220

⚡ 6-24 V

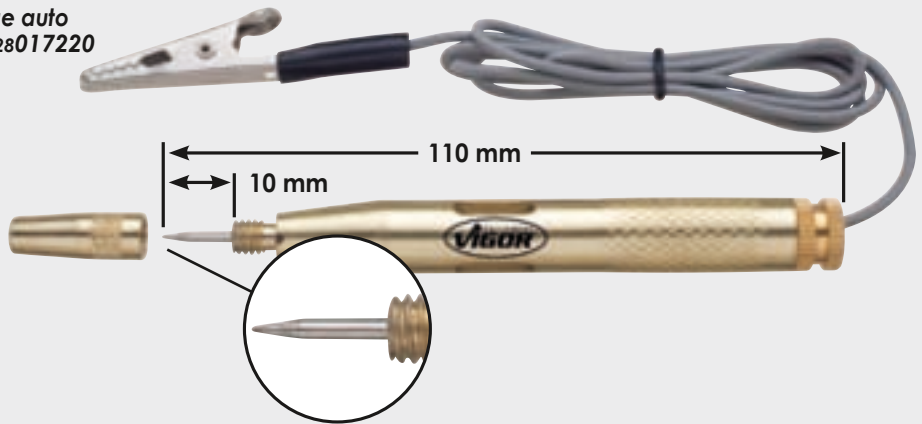

**STURDY ■ STRONG ■ GOOD**  
**PUISSANT ■ ROBUSTE ■ QUALITATIF**





**Radiator System Testing Kit  
V1963, EAN 4047728019637**

- Complete assortment for service work on radiator and heating system
- Comprehensive range of adapters suitable for all common vehicles with water-cooled engines
- 3 features: Pressure test (check for leaks in radiator system), refilling and cleaning
- Control of pressure loss via gauge
- Vacuum is generated in the radiator system.  
Advantage: Coolant is sucked in without air bubbles
- Enables refilling of even large engines without thermal influences
- Universal usage due to conical rubber radiator adapter
- Measuring range: 0 up to 2.5 bar

- Set with 25 pieces, contents:
  - 1 hand pump with gauge / hose / pressure relief valve
  - 1 adapter, black, R123 / R124
  - 1 adapter, blue, R123 / R125
  - 1 radiator adapter with bayonet fitting No. 3, large
  - 1 radiator adapter with bayonet fitting No. 4, mid-size
  - 1 radiator adapter with bayonet fitting No. 5, small
  - 11 radiator screw adapters with inside thread  
M42 x 2.5 / M42 x 3.0 / M45 x 3.0 hollow / M46 x 3.0 / M48 x 2.5 / M48 x 4.0 / M50 x 2.5 / M50 x 2.5 hollow / M50 x 3.0 / M52 x 3.0 / M60 x 4.0 mm
  - 3 radiator screw adapters with outside thread  
M34 x 3.0 / M58 x 3.0 / M62 x 3.0 mm
  - 1 vacuum filling unit up to 76 cm / Hg = 1 bar
  - 1 rubber cone adapter, 45-14 mm, length: 75 mm
  - 1 thermometer, 0-220° C / 0-400° F

**Testeur du système de refroidissement  
V1963, EAN 4047728019637**

- Assortiment complet pour les travaux de service sur le système de refroidissement et le chauffage
- Grand choix d'adaptateurs pour tous les véhicules courants à moteur refroidi par eau
- 3 modes de fonction : vérifier l'étanchéité, remplir et nettoyer
- Manomètre permet de contrôler la perte de tension
- Grace au vide créé dans le système de refroidissement, le système est rempli sans bulle
- Remplissage sans problèmes des moteurs larges sans difficulté thermique
- Utilisation universelle grâce à l'adaptateur conique en caoutchouc
- Champ de mesure : 0 jusque 2,5 bar

- Jeu de 25 pièces, contenu :
  - 1 pompe à main avec manomètre / tuyau / clapet de purge
  - 1 adaptateur testeur, noir R123 / R124
  - 1 adaptateur testeur, bleu, R123 / R125
  - 1 adaptateur avec fermeture à baïonnette No. 3, grand
  - 1 adaptateur avec fermeture à baïonnette No. 4, moyen
  - 1 adaptateur avec fermeture à baïonnette No. 5, petit
  - 11 adaptateurs vissables avec filet intérieur  
M42 x 2,5 / M42 x 3,0 / M45 x 3,0 creux / M46 x 3,0 / M48 x 2,5 / M48 x 4,0 / M50 x 2,5 / M50 x 2,5 creux / M50 x 3,0 / M52 x 3,0 / M60 x 4,0 mm
  - 3 adaptateurs vissables avec filet extérieur  
M34 x 3,0 / M58 x 3,0 / M62 x 3,0 mm
  - 1 unité de remplissage à vide avec manomètre jusque 76 cm / Hg = 1 bar
  - 1 adaptateur conique en caoutchouc, 45-14 mm, longueur : 75 mm
  - 1 thermomètre, 0-220° C / 0-400° F

Comprehensive operating instructions  
as pdf-file on "www.vigor-equipment.com"

Fichier pdf du mode d'emploi téléchargeable  
sur « www.vigor-equipment.com »





**Universal Disconnect Tool Set  
V1589, EAN 4047728015899**

- For the disconnection of various types of quick couplings on air conditioning, air, oil and fuel lines

**Jeu d'outils déconnecteurs  
V1589, EAN 4047728015899**

- Pour la déconnection de différents raccords rapides sur la climatisation, les tuyaux d'air, d'huile ou les tuyaux d'alimentation



Comprehensive application note as pdf-file on  
"www.vigor-equipment.com"

Fichier pdf de la notice d'utilisation téléchargeable sur  
« www.vigor-equipment.com »

**Anti-Freeze Tester  
V1586, EAN 4047728015868**

- For testing ethylene glycol coolant (anti-freeze) density in passenger cars, trucks, etc.

**Appareil de contrôle d'antigel  
V1586, EAN 4047728015868**

- Pour les solutions d'eau et glycol éthylénique dans le circuit de refroidissement des voitures de tourisme, camions, etc.



**TDC-Finder  
V1766, EAN 4047728017664**

- A tool for locating the top dead centre (TDC) position on petrol and diesel engines as well as for engine timing and timing pin insertion
- TDC-Finder to be inserted in the spark plug or glow plug hole. It indicates, by definite movement of the floater, when the piston has reached the TDC-position
- Please follow the instructions of the vehicles manufacturer!

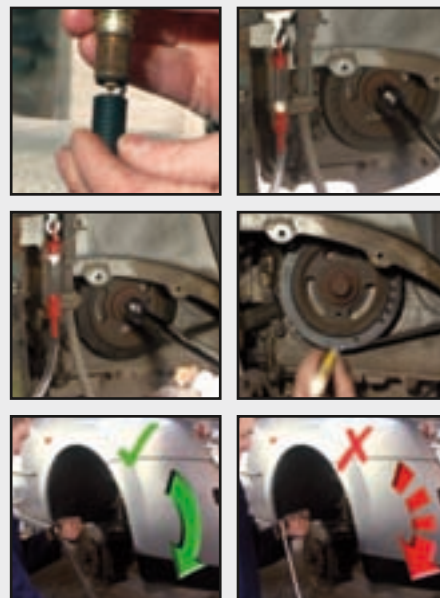

**Outil pour la détermination du PMH  
V1766, EAN 4047728017664**

- Un outil pour localiser la position du PMH aux moteurs diesel et moteurs à essence, pour le calage de la distribution et pour l'insertion de la goupille de réglage
- L'outil est inséré dans l'ouverture de la bougie ou de la bougie de préchauffage et indique par mouvement distinct du flotteur quand le piston atteint le point mort haut.
- Respectez les instructions du constructeur de véhicule!



Comprehensive application note as pdf-file on  
"www.vigor-equipment.com"

Fichier pdf de la notice d'utilisation téléchargeable sur  
« www.vigor-equipment.com »

Application CD  
included  
CD de démonstration  
inclus

### Oil Dipstick Set MERCEDES-BENZ V2112, EAN 4047728021128

- For measuring the oil level of motor control and automatic gearboxes
- Essential after each oil change (Vehicle delivery by the manufacturer without dipsticks but only with sealing plug)

### Jeu de jauges de niveau d'huile MERCEDES-BENZ V2112, EAN 4047728021128

- Pour mesurer le niveau d'huile du moteur et de la transmission automatique
- Outil indispensable après la vidange d'huile (véhicule est livrée sans jauges, les réservoirs se ferment par un bouchon)



Available from August 2011  
Livrable à partir du mois d'août 2011

Comprehensive application note as pdf-file on "www.vigor-equipment.com"  
Fichier pdf de la notice d'utilisation téléchargeable sur " www.vigor-equipment.com "



### Oil Filter Wrench Set V1282, EAN 4047728012829

- 14 oil filter wrenches
- 1 adapter  $\frac{3}{8}$ " outside square /  $\frac{1}{2}$ " inside square, with outside hexagon size 21 mm



### Jeu de clés pour filtres à huile V1282, EAN 4047728012829

- 14 clés pour filtres à huile
- 1 adaptateur  $\frac{3}{8}$ " carré mâle /  $\frac{1}{2}$ " carré femelle, avec six pans mâle 21 mm

Ø mm	Step / Degré	Groove / Cannelure	Flutes / Arêtes	Cars / Véhicules
65	1		14	DAIHATSU, TOYOTA, NISSAN, FIAT
65-67	1		14	DAIHATSU, TOYOTA
68	1		14	MAZDA, FORD, SUBARU
73	1		14	TOYOTA, LEXUS
74-76	2		15	FORD, OPEL, VW, AUDI, MERCEDES-BENZ
75-77	2		15	VW, AUDI, ISUZU, MERCEDES-BENZ
76			14	VW, PORSCHE, MERCEDES-BENZ, BMW, AUDI, OPEL
76	1	30		FORD
80	1		15	NISSAN, HONDA, OPEL, MAZDA
80-82	2		15	SUBARU, TOYOTA, HONDA, NISSAN
90	1		15	HONDA, MITSUBISHI, ISUZU
93	1		15	MAZDA, VOLVO, MITSUBISHI, NISSAN, HONDA
93	1	36		FORD
100	1		15	ISUZU, MITSUBISHI



### Oil Filter Wrench for passenger cars V1281, EAN 4047728012812

- Drive optionally:  $\frac{1}{2}$ " inside square /  $\frac{1}{2}$ " inside square or size 21 mm
- outside hexagon
- 1 adapter  $\frac{3}{8}$ " outside square /  $\frac{1}{2}$ " inside square, with outside hexagon size 21 mm



### Clé pour filtres à huile pour voitures de tourisme V1281, EAN 4047728012812

- Entraînement au choix :  $\frac{1}{2}$ " carré femelle /  $\frac{1}{2}$ " carré femelle ou 21 mm
- six pans mâle
- 1 adaptateur  $\frac{3}{8}$ " carré mâle /  $\frac{1}{2}$ " carré femelle avec 6 pans mâle 21 mm



## SAC Clutch Alignment Tool Set V2306, EAN 4047728023061



- For almost all SAC (self-adjusting) clutches with 3 hole division.
- For the fast and professional removing and installation of SAC clutches
- Without this tool set a correct installation is almost impossible
- With centring option of the clutch and resetting of the adjusting ring
- Prevents distortion of the adjusting ring in the clutch pressure plate
- For damage-free working on the pressure plate
- Avoids malfunctions (bad separating, slipping or judder)

## Jeu d'outils pour embrayages SAC V2306, EAN 4047728023061



- Pour presque tous les embrayages SAC (à compensation automatique) à 3 trous
- Pour le montage et démontage rapide et approprié des embrayages SAC
- Sans ce jeu d'outils le montage correct de l'embrayage est presque impossible
- Permet le centrage de l'embrayage et la remise de l'anneau de réglage
- Empêche la distorsion de l'anneau de réglage dans la plaque de pression d'embrayage
- Pour les travaux sur la plaque de pression d'embrayage sans l'abîmer
- Évite défaillance (mal séparer, dérapage ou broutage)



Comprehensive application note as pdf-file on  
"www.vigor-equipment.com"

Fichier pdf de la notice d'utilisation  
téléchargeable sur  
« www.vigor-equipment.com »

Available from August 2011

Livrable à partir du  
mois d'août 2011

## Expansion Set for SAC Clutch Alignment Tool Set V2308, EAN 4047728023085



Jeu complémentaire pour le jeu  
d'outils pour embrayages SAC  
V2306, EAN 4047728023085



Available from August 2011

Livrable à partir du  
mois d'août 2011



## Tube Flaring Tool Set V1728, EAN 4047728017282

- Light-weight
- Especially suited for direct application on brake and hydraulic lines on vehicles
- For thin-walled pipes made of steel, aluminium and copper, metric / inch
- For convex and double flares (DIN / SAE-standards)
- No damage to coated lines
- Contents:
  - 1 Set of gripping jaws 4.75 mm
  - 1 Set of gripping jaws 5.00 mm
  - 1 Set of gripping jaws 6.00 mm
  - 1 Thrust Block 4.75 mm SAE / DIN
  - 1 Thrust Block 5.00 mm SAE / DIN
  - 1 Thrust Block 6.00 mm SAE
  - 1 Thrust Block 6.00 mm DIN
  - 1 90° Thrust Block 4.75 ~ 6 mm SAE 90°
  - 1 Tube Flaring Unit
  - 1 Quick-change holder
  - 1 Hydraulic spindle

## Jeu d'outils à collets V1728, EAN 4047728017282

- Léger et maniable
- Particulièrement approprié à la manœuvre directe des conduites de frein et de la tuyauterie hydraulique sur véhicules
- Pour conduits en acier, aluminium et cuivre à paroi fine, métrique / pouce
- Pour collets convexes ou doubles (normes DIN / SAE)
- Pas d'endommagements des conduites revêtues
- Contenu:
  - 1 Jeu de mâchoires de serrage 4,75 mm
  - 1 Jeu de mâchoires de serrage 5,00 mm
  - 1 Jeu de mâchoires de serrage 6,00 mm
  - 1 Pièce de pressage 4,75 mm SAE / DIN
  - 1 Pièce de pressage 5,00 mm SAE / DIN
  - 1 Pièce de pressage 6,00 mm SAE
  - 1 Pièce de pressage 6,00 mm DIN
  - 1 90° Pièce de pressage 4,75 ~ 6 mm SAE 90°
  - 1 Corps d'appareil à collets
  - 1 Crochet de changement rapide
  - 1 Broche hydraulique



Comprehensive operating instructions  
as pdf-file on  
"www.vigor-equipment.com"  
Fichier pdf du mode d'emploi  
téléchargeable sur  
« www.vigor-equipment.com »





## Brake Line Wrench Set V1805, EAN 4047728018050

- With joint for application on brake line screws with restricted access
- Especially suitable for application in areas with restricted and difficult access such as brake lines, air conditioning lines, power steering lines, vacuum lines, compressed air and fuel lines



## Jeu de clés pour la tuyauterie de frein V1805, EAN 4047728018050

- Têtes articulées permettant de manœuvrer les vissages de la tuyauterie de frein d'accès difficile
- Bien approprié à l'utilisation dans les espaces réduits et difficiles comme par ex. sur les tuyaux de freins, de climatisation, de la direction assistée et sur les tuyaux à vide, d'air comprimé et d'alimentation

VIGOR No.	 mm	 mm	EAN 4047728+
V1841	8 x 9	120	018418
V1842	10 x 11	160	018425
V1843	12 x 13	180	018432
V1844	14 x 15	210	018449



## Tube Bending Tool V1782, EAN 4047728017824

- For tubes made of copper, brass, aluminium and soft steel

## Outil à cintrer les tuyaux V1782, EAN 4047728017824

- Pour tuyaux en cuivre, laiton, aluminium et acier doux

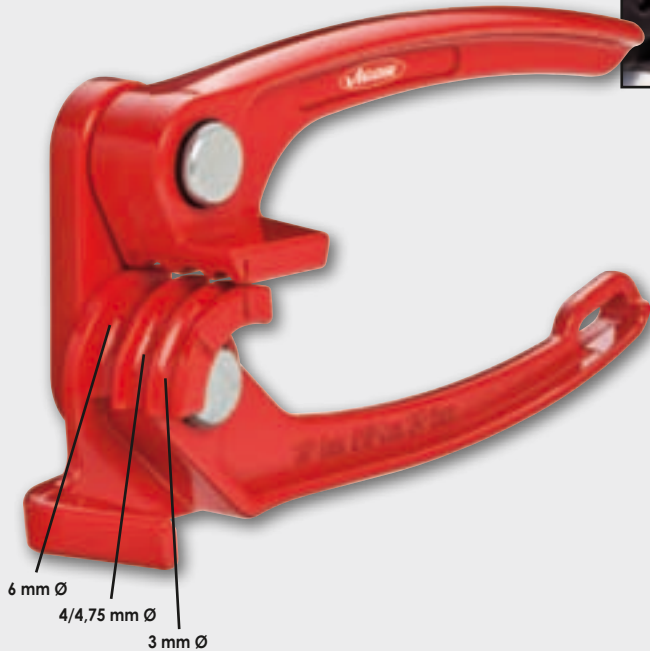

**Brake Calliper Brush, steel  
V2250, EAN 4047728022507**

- For removal of brake dust
- Allow working in areas with restricted access

**Brosse pour étrier de frein en acier  
V2250, EAN 4047728022507**

- Pour éliminer la poussière tenace des freins
- Pour l'accès aux endroits étroits



With suspension hole  
Avec trou de suspension



**Brake Calliper Brush, brass  
V2249, EAN 4047728022491**

- For cleaning aluminium brake callipers
- For removal of brake dust
- Allow working in areas with restricted access

**Brosse pour étrier de frein en laiton  
V2249, EAN 4047728022491**

- Pour le nettoyage des étriers de frein d'aluminium
- Pour éliminer la poussière tenace des freins
- Pour l'accès aux endroits étroits



With suspension hole  
Avec trou de suspension



**STURDY ■ STRONG ■ GOOD  
PUISSANT ■ ROBUSTE ■ QUALITATIF**





**Pneumatic Brake Piston  
Readjusting Set**  
V1711, EAN 4047728017114

- Universal set for readjusting, i.e. pushing and turning brake pistons on nearly all passenger cars
- Rotation possible to left and right
- Set with 16 pieces consisting of:  
1 pneumatic spindle and 15 adapter plates

**Jeu d'outils pneumatiques  
pour pistons de freins**  
V1711, EAN 4047728017114

- Jeu universel pour pousser et tourner les pistons de freins sur presque toutes les voitures de tourisme
- Rotation à gauche et à droite possible
- Jeu de 16 pièces comprenant:  
1 vis pneumatique et 15 adaptateurs



**Comprehensive application  
note as pdf-file on  
"www.vigor-equipment.com"**  
**Fichier pdf de la notice d'utilisation  
téléchargeable sur  
« www.vigor-equipment.com »**

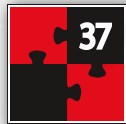

**Brake Piston Tool Set**  
V1590, EAN 4047728015905

- New system suitable for push-back and wind-back brake pistons
- Set with 37 pieces consisting of:  
2 thrust bolt assemblies (left-handed and right-handed)  
2 allen keys (6 and 7mm),  
2 drift pins,  
3 exchangeable reaction plates  
27 reaction plates and adapters,  
1 lubricating oil
- Adapters enable application even on worn brake linings

**Jeu d'outils de pistons de frein**  
V1590, EAN 4047728015905

- Nouveau système, approprié aux pistons tournants à gauche et à droite
- Jeu de 37 pièces comprenant :  
2 vis (tournant à gauche et à droite),  
2 tournevis coudés (6 et 7 mm)  
2 chasse-goupilles,  
3 plaques de butées échangeables  
27 plaques de butées et adaptateurs,  
1 bouteille d'huile
- L'adaptateur permet l'utilisation avec des garnitures de frein usées



**Comprehensive application  
note as pdf-file on  
"www.vigor-equipment.com"**  
**Fichier pdf de la notice d'utilisation  
téléchargeable sur  
« www.vigor-equipment.com »**

**Universal Track Rod Wrench Set**

For screwed connections on hydraulic systems, air conditioning units, sanitary installations, track rod, O2 sensors, diesel injection pumps

**Jeu de clés universelles pour conduits et barres d'accouplements**

Utilisation entre autre sur vissages des systèmes hydrauliques, climatisation, installations sanitaires, barres d'accouplements, capteurs O2 et pompes à injection diesel

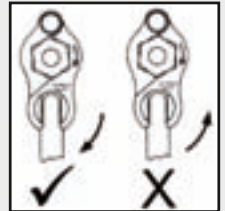
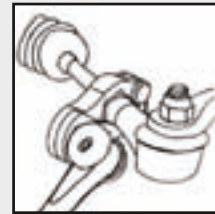
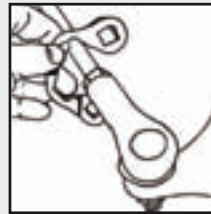

11-16 mm  
V1401, EAN 4047728014014

- Operation with  $\frac{3}{8}$ " reversible ratchet
- Sizes 11; 12-13; 14; 16 mm
- Inch measures:  $\frac{7}{16}$ ";  $\frac{1}{2}$ ";  $\frac{9}{16}$ ";  $\frac{5}{8}$ "

11-16 mm  
V1401, EAN 4047728014014

- Utilisation avec un cliquet de  $\frac{3}{8}$ "
- Dimensions 11; 12-13; 14; 16 mm
- Pouces :  $\frac{7}{16}$ ";  $\frac{1}{2}$ ";  $\frac{9}{16}$ ";  $\frac{5}{8}$ "

17-24 mm  
V1403, EAN 4047728014038

- Operation with  $\frac{1}{2}$ " reversible ratchet
- Sizes 17-18; 19-20; 21-22; 23-24 mm
- Inch measures:  $\frac{11}{16}$ ";  $\frac{3}{4}$ ";  $\frac{13}{16}$ " -  $\frac{7}{8}$ ";  $\frac{15}{16}$ "

17-24 mm  
V1403, EAN 4047728014038

- Utilisation avec un cliquet de  $\frac{1}{2}$ "
- Dimensions 17-18; 19-20; 21-22; 23-24 mm
- Pouces  $\frac{11}{16}$ ";  $\frac{3}{4}$ ";  $\frac{13}{16}$ " -  $\frac{7}{8}$ ";  $\frac{15}{16}$ "



Wheel Wrench  
V1614, EAN 4047728016148

Clé en croix  
V1614, EAN 4047728016148

12<sup>5</sup> 1/2"



SW 17 SW 19 SW 21 SW 23  
To be used on both sides  
Utilisable des deux côtés



Cap Remover  
V1462, EAN 4047728014625

- For installing and removing protecting caps of wheel bolts
- Tube handle can be used for storage of all protective caps of one car (20 pcs.)

Extracteur de capuchons de protection  
V1462, EAN 4047728014625

- Pour le montage et démontage des capuchons de protection des boulons de roues
- Manche tubulaire permet de ranger tous les capuchons de protection d'une véhicule (20 capuchons en total)

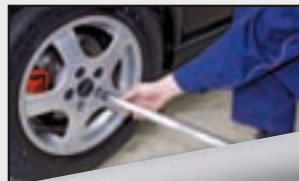

17 mm

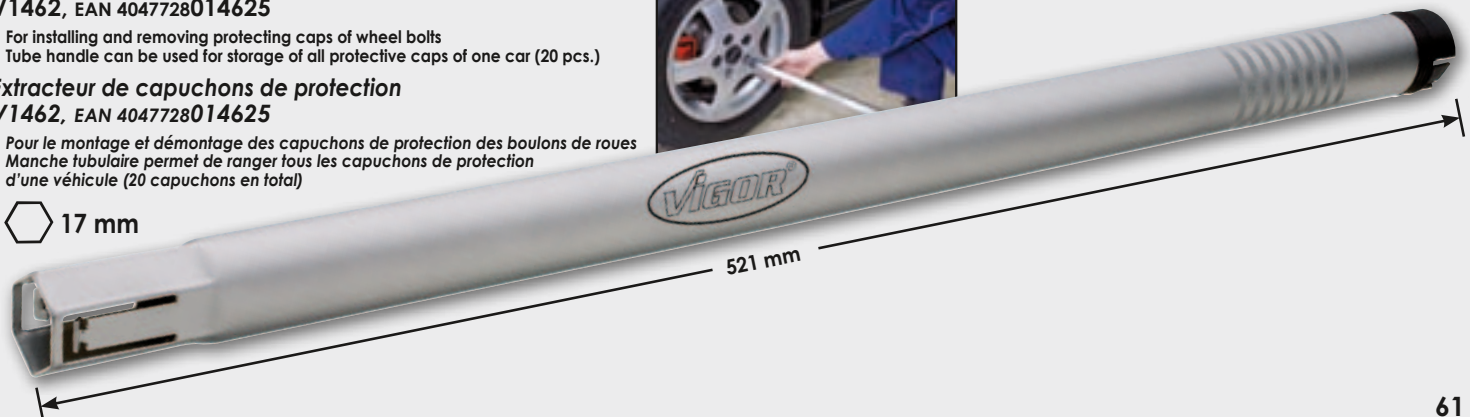

**Steering Wheel Level**  
V1571, EAN 4047728015714



**Niveau à bulle pour volant**  
V1571, EAN 4047728015714

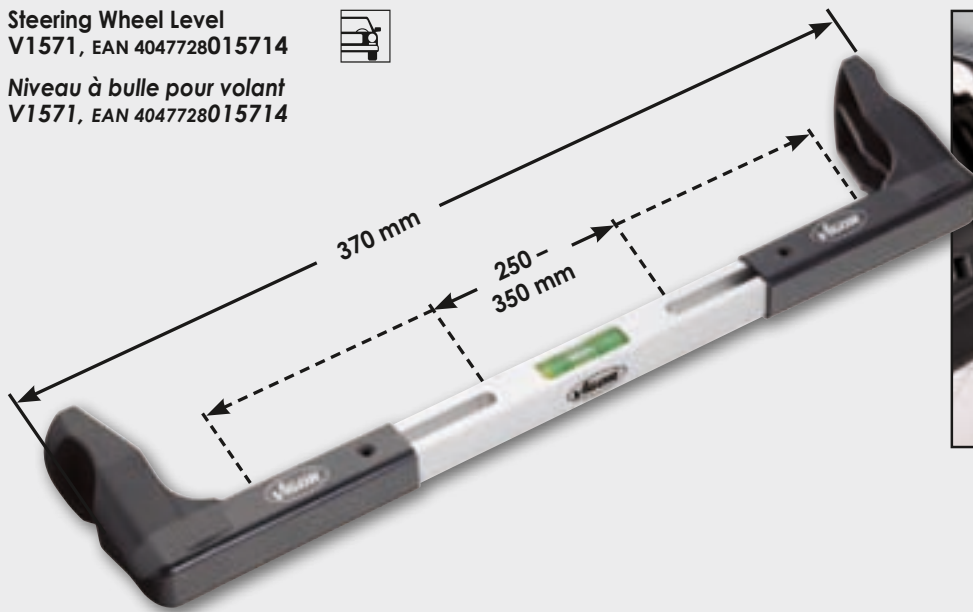

**Balance Weight Pliers**  
V1657, EAN 4047728016575

**Pince à masses d'équilibrage**  
V1657, EAN 4047728016575

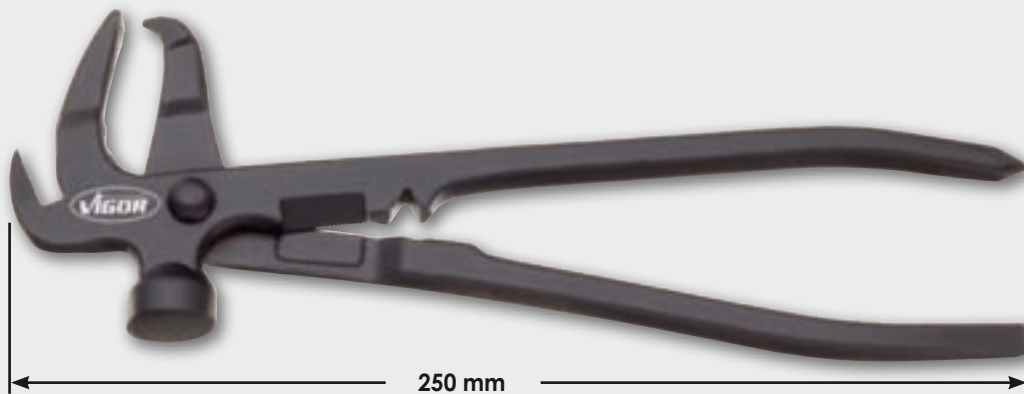

**Hydraulic Service Jack**  
V1436, EAN 4047728014366



- With overload protection
- Castors with reduced rolling resistance

**Cric de service hydraulique**  
V1436, EAN 4047728014366

- Protection contre la surcharge
- Galets silencieux à résistance réduite



**Comprehensive operating instructions as pdf-file on**  
**"www.vigor-equipment.com"**

**Fichier pdf du mode d'emploi téléchargeable sur**  
**" www.vigor-equipment.com "**

**Tire Depth Gauge**

**V1584, EAN 4047728015844**

- Zero-setting possible in any position
- Suitable for detecting wear patterns on tires, brake shoes and brake linings
-  3 V (CR 2032) – 240 mAh

**Jauge d'usure des pneus**

**V1584, EAN 4047728015844**

- Remise à zéro possible en n'importe quelle position
- Utilisable pour mesurer l'usure des pneus, des plaquettes de frein à disque et des garnitures de frein
-  3 V (CR 2032) – 240 mAh

max. 27 mm →

mm ↔  
inch ↔



**Tire Pressure Gauge**

**V1423, EAN 4047728014236**

- Range readable in three different units: 0.15 to 7.00 bar, 2 to 99.5 PSI, 15 to 70 KPA
-  3 V (CR 2032) – 240 mAh

**Appareil de contrôle de pression des pneus**

**V1423, EAN 4047728014236**

- 3 unités de mesure possible 0,15 jusque 7 bar, 2 jusque 99,5 PSI, 15 jusque 70 KPA
-  3 V (CR 2032) – 240 mAh





bar ↔  
PSI ↔  
KPA ↔



128 mm

**Special Twist Socket Set**



**V1378, EAN 4047728013789**

- Special profile for loosening aluminium rim locks, unscrewing tight wheel nuts and bolts with damaged heads
- Sockets useable on both sides:
  1. as usual socket / 2. as truning cutting thread
- Set consisting of:  Special-Twist-Impact-Socket 17 mm  
 Special-Twist-Impact-Socket 19 mm  
 Special-Twist-Impact-Extension 60 mm



**Jeu de douilles spéciales pour dévisser**

**V1378, EAN 4047728013789**

- Profil spécial pour verrous de jantes, pivots de roues grippés et écrous à tête arrondie par l'usure
- Douilles utilisables dans les 2 sens :
  1. comme douille normale / 2. comme filière spéciale
- Jeu composé de :  Douille spéciale pour dévisser 17 mm pour clé à chocs  
 Douille spéciale pour dévisser 19 mm pour clé à chocs  
 Rallonge 60 mm pour clé à chocs



**2.5 kg Rubber Hammer**  
**V2235, EAN 4047728022354**

- Especially for loosening of rusted rims during tyre change
- Non-rebound due to steel-ball filling in the hammer head

**Massette plastique de 2,5 kg**  
**V2235, EAN 4047728022354**

- En particulier pour enlever la rouille de la jante lors du changement des pneus
- Sans rebond, tête est remplie de billes en acier

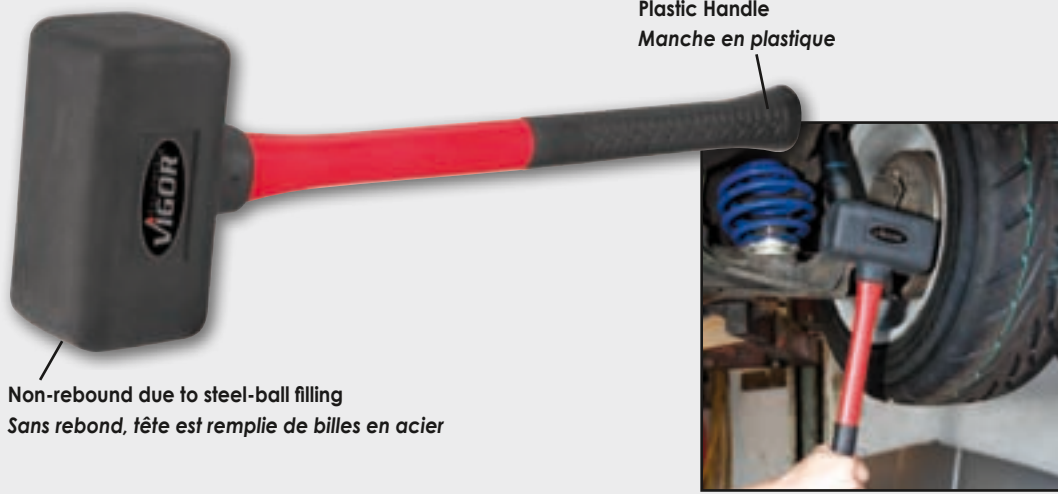

**5 kg Rubber Hammer**  
**V2234, EAN 4047728022347**

- Extra heavy design, especially suitable for commercial vehicles
- Especially for loosening of rusted rims during tyre change
- Non-rebound due to steel-ball filling in the hammer head

**Massette plastique de 5 kg**  
**V2234, EAN 4047728022347**

- Modèle extrêmement lourd, bien approprié aux véhicules utilitaires
- En particulier pour enlever la rouille de la jante lors du changement des pneus
- Sans rebond, tête est remplie de billes en acier



**STURDY ■ STRONG ■ GOOD**  
**PUISSANT ■ ROBUSTE ■ QUALITATIF**





Chassis / Wheels / Tires  
Châssis / Roues / Pneus

EQUIPMENT  
**VIGOR**

Impact Socket Set  
V2257, EAN 4047728022576  
• Sizes 15, 17, 19, 21, 22 mm

12<sup>5</sup> 1/2"



Jeu de douilles à chocs  
V2257, EAN 4047728022576  
• Tailles 15, 17, 19, 21, 22 mm



**NEW**  
**NOUVEAU**  
**NOUVEAU**  
**NEW**



**STURDY ■ STRONG ■ GOOD**  
**PUISSANT ■ ROBUSTE ■ QUALITATIF**

EQUIPMENT  
**VIGOR**



[www.vigor-equipment.com](http://www.vigor-equipment.com)



**Wiperarm Puller Set**  
**V1451, EAN 4047728014519**

- 8 pcs. set consisting of:  
1 remover,  
1 pressure spindle and  
6 different extractors



**Jeu d'outils pour démonter les bras des essuie-glaces**  
**V1451, EAN 4047728014519**

- Jeu de 8 pièces composé de :  
1 extracteur à frapper,  
1 vis de pression et  
6 cloches à extraction différentes



**Comprehensive application note as pdf-file on**  
**"www.vigor-equipment.com"**  
**Fichier pdf de la notice d'utilisation téléchargeable sur**  
**" www.vigor-equipment.com "**

**Spreading Pad**  
**V1784, EAN 4047728017848**

- For universal use e.g. door opening, positioning, fixing and pushing away car body parts, inner linings etc.

**Écarteur à air**  
**V1784, EAN 4047728017848**

- Application universelle pour ouvrir les portes, positionner, fixer et écarter les parties de la carrosserie, le revêtement intérieur etc.



**Tensioning Ratchet**  
V2236, EAN 4047728022361

- For easy installation of clips (Free-end and prefabricated).
- For clips of 6mm to 10mm width

**Cliquet tendeur**  
V2236, EAN 4047728022361

- Pour faciliter le montage des colliers à bande et à spirales (sans-fin et préfabriqués)
- Pour des colliers à bande d'une largeur de 6 à 10 mm



Available from  
August 2011  
**Livrable à partir  
du mois d'août  
2011**

Comprehensive application note as pdf-file on  
"www.vigor-equipment.com"  
Fichier pdf de la notice d'utilisation téléchargeable sur  
« www.vigor-equipment.com »

**Exhaust Pipe Flaring Tool**  
V2057, EAN 4047728020572

- For easy installation of mufflers and pipes
- Conical exhaust pipe flaring tool facilitates easy flaring of exhaust tailpipes
- Professional adjustment of inaccuracies of fit due to pipe deformation or tolerances of pipe diameters due to production
- Easy installation of all exhaust pipe elements by plug connections

**Expandeur pour le tuyau  
d'échappement**  
V2057, EAN 4047728020572

- Pour le montage facile du silencieux et des tuyaux
- Forme conique permettant l'expansion simple des tuyaux d'échappement
- Permet de corriger les déformations des tuyaux et les tolérances des diamètres des tuyaux
- Montage facile des éléments du tuyaux échappement avec connecteurs



# VIGOR 500

Tool Trolley and tool assortment  
 Servante d'atelier avec assortiment d'outils  
 V2379, EAN 4047728023795

**Black Edition!**  
**Édition noire!**



H 930 x W 700 x D 400 mm  
 H 930 x L 700 x P 400 mm

**Tool Trolley**  
**Servante d'atelier**  
**Made in Germany!**



Drawer 1 / Tiroir 1



V2378

Drawer 2 / Tiroir 2



V2375

Drawer 3 / Tiroir 3



V2376

Assortiment w/o trolley:  
 V2307, EAN 4047728023078

Assortiment sans servante :  
 V2307, EAN 4047728023078

Please contact us: / Veuillez nous contacter :

All rights reserved regarding technical modifications. Figures may not always correspond to the original and are thus not binding. Errors and omissions excepted. / Sous réserve de modifications techniques et erreurs. Les illustrations ne correspondent pas toujours à la dernière exécution et sont de ce fait sans engagement. Nous ne sommes pas responsables des erreurs d'impression. © Copyright 2011 by VIGOR GmbH